



Medium Voltage Indoor Voltage Transformer Models PTG3-1-60 & PTG3-2-60

REGULATORY AGENCY APPROVALS



Manufactured to meet the requirements of ANSI/IEEE C57.13.

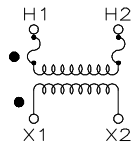
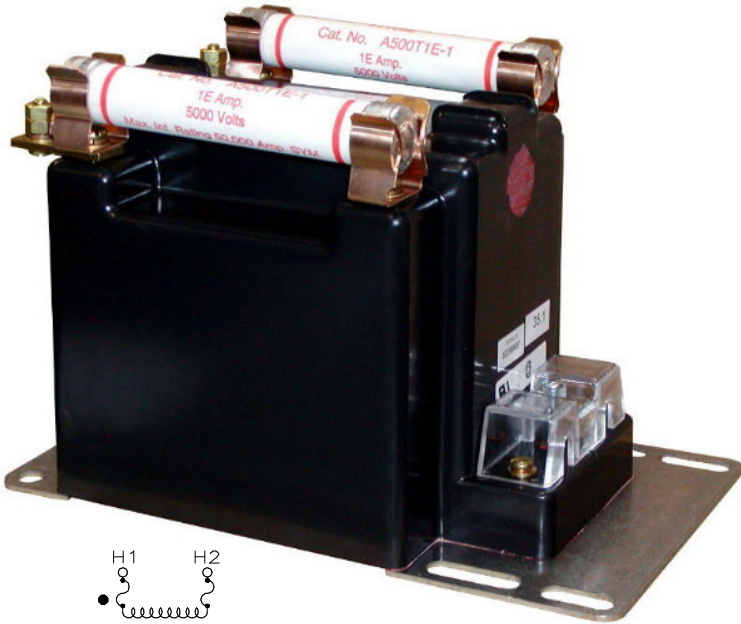

TWO FUSE
Two Bushing

ACCURACY CLASS:

0.3 WXY 1.2 Z at 100% rated voltage with 120V based ANSI burden.

0.6 WX, 1.2 MY at 58% rated voltage with 69.3V based ANSI burden.

FREQUENCY:

60 Hz.

MAXIMUM SYSTEM VOLTAGE:

5.6kv, BIL 60kv.

THERMAL RATING:

750 VA at 30°C amb.

500 VA at 55°C amb.

Approximate weight 34 lbs. unfused.

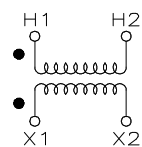
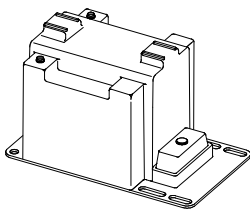

UNFUSED
Two Bushing

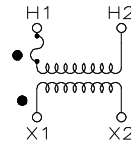
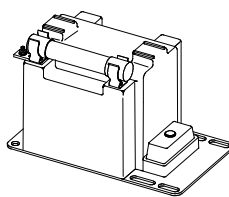

ONE FUSE
One Bushing

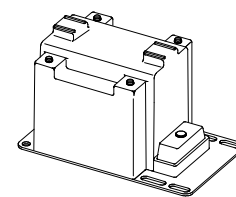

**SWITCHGEAR
STYLE**
Two Bushing

TWO BUSHING (a)				CATALOG NUMBERS			
GROUP	PRIMARY VOLTAGE	RATIO	SECONDARY VOLTAGE	UNFUSED	FUSES	FUSE CLIPS ONLY (d)	SWITCHGEAR STYLE
1	*2400	20:1	120	PTG3-2-60-242	PTG3-2-60-242FF	PTG3-2-60-242CCS or CCL	PTG3-2-60-242SS
2	3300	30:1	110-50 Hz	PTG3-2-60-332	PTG3-2-60-332FF	PTG3-2-60-332CCS or CCL	PTG3-2-60-332SS
2	*4200	35:1	120	PTG3-2-60-422	PTG3-2-60-422FF	PTG3-2-60-422CCS or CCL	PTG3-2-60-422SS
2	*4800	40:1	120	PTG3-2-60-482	PTG3-2-60-482FF	PTG3-2-60-482CCS or CCL	PTG3-2-60-482SS

ONE BUSHING (b)				CATALOG NUMBERS			
GROUP	PRIMARY VOLTAGE	RATIO	SECONDARY VOLTAGE	R FR (c)	FUSES	FUSE CLIPS ONLY (d)	SWITCHGEAR STYLE
4A	*2400	20:1	120	230	PTG3-1-60-242F	PTG3-1-60-242CS or CL	PTG3-1-60-242S
4B	*4200	35:1	120	230	PTG3-1-60-422F	PTG3-1-60-422CS or CL	PTG3-1-60-422S
4B	*4800	40:1	120	230	PTG3-1-60-482F	PTG3-1-60-482CS or CL	PTG3-1-60-482S

NOTE: All Primary voltages marked with an asterisk (*) are approved for revenue metering in Canada by Industry Canada, Approval No. T-215 Rev. 02

Models PTG3-1-60 & PTG3-2-60

(a) Two fuse transformers should not be used for Y connections. It is preferred practice to connect one lead from each voltage transformer directly to the neutral terminal, using a fuse in the line side of the primary only. By using this connection a transformer can never be made "live" from the line side by reason of a blown fuse in the neutral side. For continuous operation the transformer primary voltage should not exceed 110% of rated value.

(b) Voltage transformers connected line-to-ground cannot be considered to be grounding transformers and must not be operated with the secondaries in closed delta because excessive currents may flow in the delta.

(c) See page 32, item 1 for ferroresonance considerations. Values in table are in ohms.

(d) Fuse clips noted as "CCS" or "CS" accept fuses with 1" Dia. caps and 5" clip centers. Fuses clips noted as "CCL" or "CL" accept fuses with 1.63" Dia. caps and 5.88" clip centers.

Note: It is recommended that system line-to-line voltage not exceed the transformer maximum system voltage level.

FUSE FOR MODEL PTG3 TRANSFORMER	RATING VOLTS	INTERRUPTING AMPERES (SYM)	SUGGESTED RATING CONTINUOUS AMPERES	CAP DIA. INCHES (d)	LENGTH INCHES	CLIP CENTERS INCHES
2400:120V	5.5kV	45,000	2.0E	1.0	5.63	5.00
3300:110V	5.5kV	45,000	2.0E	1.0	5.63	5.00
4200:120V	5.5kV	45,000	1.0E	1.0	5.63	5.00
4800:120V	5.5kV	45,000	1.0E	1.0	5.63	5.00

- Primary terminals that are unfused are 1/4-20 brass screws with one flatwasher and lockwasher.
- Primary terminals that are fused are 1/4-20 brass screws with one flatwasher and lockwasher and two nuts.
- Secondary terminals are No. 10-32 brass screws with one flatwasher and lockwasher.
- The core and coil assembly is encased in a plastic enclosure and vacuum encapsulated in polyurethane resin.
- Thermal burden rating is for 120 volt secondaries.
- Switch gear style is similar to fused style. No fuse or fuse clip is provide, but inserts for fuse clips are supplied.

RECOMMENDED MINIMUM SPACINGS

A = Unit to Unit = 0.75" minimum.

B = HV to Ground in air = 3.00" minimum.

Recommended spacing are for guidance only. User needs to set appropriate values to assure performance for high potential test, impulse test, high humidity, partial discharge, high altitude, and other considerations like configuration.

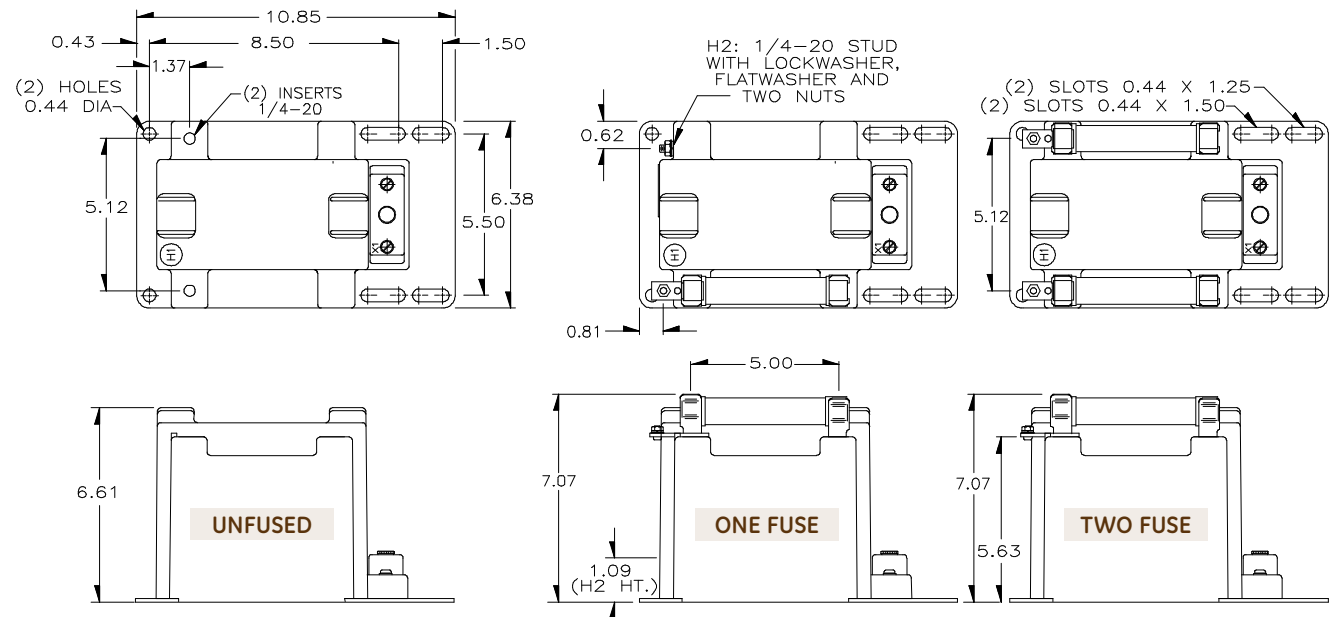
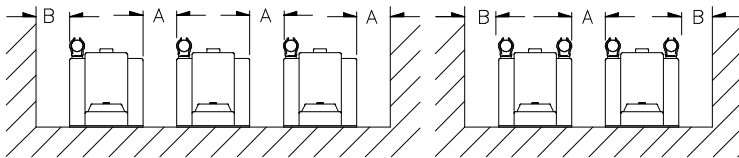

CIRCLE DIAGRAM

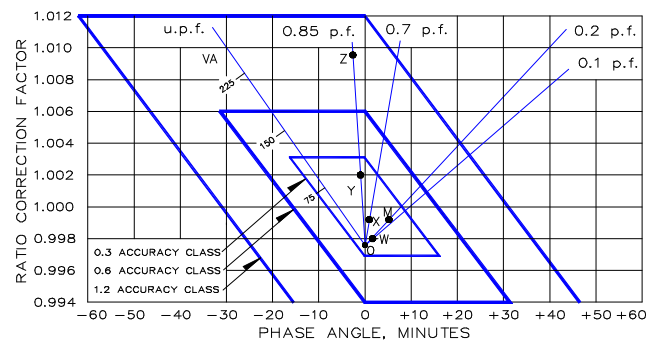

The circle diagram can be used to predict the performance of a transformer for various loads and power factors. A convenient scale of volt-ampere is shown on the unity power factor line (u.p.f) and commences at the zero or no-load locus. To use the diagram, measure the known V.A. and scribe an arc about the "Zero" locus of a length that contains the angle of the burden power factor. The point at which the arc terminates is the error locus in phase angle minutes and ratio correction factor.