

REGULATORY AGENCY APPROVALS

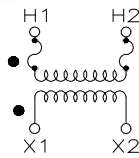

Manufactured to meet the requirements of ANSI/IEEE C57.13.



TWO FUSE
Two Bushing

ACCURACY CLASS:

0.3. WXYZ 1.2 ZZ at 100% rated voltage with 120V based ANSI burden.

0.3 WXY, 1.2Z at 58% rated voltage with 69.3V based ANSI burden.

FREQUENCY:

60 Hz.

MAXIMUM SYSTEM VOLTAGE:

15.5kV, BIL 110kV.

THERMAL RATING:

1500 VA at 30°C amb.

1000 VA at 55°C amb.

Approximate weight 85 lbs. unfused.

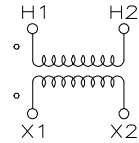
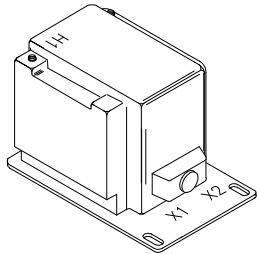

UNFUSED
Two Bushing

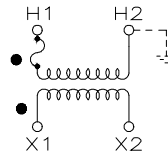
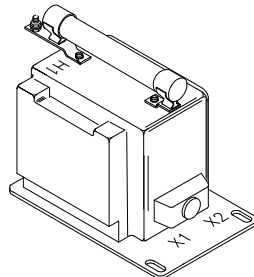

ONE FUSE
One Bushing

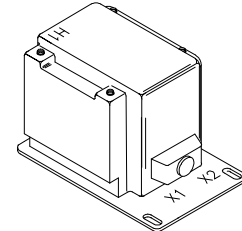

**SWITCHGEAR
STYLE**
Two Bushing

TWO BUSHING (a)				CATALOG NUMBERS			
GROUP	PRIMARY VOLTAGE	RATIO	SECONDARY VOLTAGE	UNFUSED	FUSES	FUSE CLIPS ONLY	SWITCHGEAR STYLE
1	*7200	60:1	120	PTW5-2-110-722	PTW5-2-110-722FF	PTW5-2-110-722CC	PTW5-2-110-722SS
1	*8400	70:1	120	PTW5-2-110-842	PTW5-2-110-842FF	PTW5-2-110-842CC	PTW5-2-110-842SS
2	11000	100:1	110-50Hz	PTW5-2-110-113	PTW5-2-110-113FF	PTW5-2-110-113CC	PTW5-2-110-113SS
2	*12000	100:1	120	PTW5-2-110-123	PTW5-2-110-123FF	PTW5-2-110-123CC	PTW5-2-110-123SS
2	13200	110:1	120	PTW5-2-110-1322	PTW5-2-110-1322FF	PTW5-2-110-1322CC	PTW5-2-110-1322SS
2	*14400	120:1	120	PTW5-2-110-1442	PTW5-2-110-1442FF	PTW5-2-110-1442CC	PTW5-2-110-1442SS

ONE BUSHING (b)				CATALOG NUMBERS			
GROUP	PRIMARY VOLTAGE	RATIO	SECONDARY VOLTAGE	R _{FR} (c)	FUSES	FUSE CLIPS ONLY	SWITCHGEAR STYLE
4A	*7200	60:1	120	65	PTW5-1-110-722F	PTW5-1-110-722C	PTW5-1-110-722S
4A	*8400	70:1	120	65	PTW5-1-110-842F	PTW5-1-110-842C	PTW5-1-110-842S
4B	11000	100:1	110-50Hz	65	PTW5-1-110-113F	PTW5-1-110-113C	PTW5-1-110-113S
4B	*12000	100:1	120	65	PTW5-1-110-123F	PTW5-1-110-123C	PTW5-1-110-123S
4B	13200	110:1	120	65	PTW5-1-110-1322F	PTW5-1-110-1322C	PTW5-1-110-1322S
4B	*14000	120:1	120	65	PTW5-1-110-1442F	PTW5-1-110-1442C	PTW5-1-110-1442S

NOTE: All Primary voltages marked with an asterisk (*) are approved for revenue metering in Canada by Industry Canada, Approval No. AE-0431 Rev.01

Models PTW5-1-110 & PTW5-2-110

(a) Two fuse transformers should not be used for Y connections. It is preferred practice to connect one lead from each voltage transformer directly to the neutral terminal, using a fuse in the line side of the primary only. By using this connection a transformer can never be made "live" from the line side by reason of a blown fuse in the neutral side. For continuous operation the transformer primary voltage should not exceed 110% of rated value.

(b) Voltage transformers connected line-to-ground cannot be considered to be grounding transformers and must not be operated with the secondaries in closed delta because excessive currents may flow in the delta.

(c) See page 32, item 1 for ferroresonance considerations. Values in table are in ohms.

Note: It is recommended that system line-to-line voltage not exceed the transformer maximum system voltage level.

FUSE FOR MODEL PTW5 TRANSFORMER	RATING VOLTS	INTERRUPTING AMPERES (SYM)	SUGGESTED RATING CONTINUOUS AMPERES	CAP DIA. INCHES	LENGTH INCHES	CLIP CENTERS INCHES
7200:120V	15.5kV	80,000	1.0E	1.63	13	11.50
4800:120V	15.5kV	80,000	1.0E	1.63	13	11.50
11000:120V	15.5kV	80,000	0.5E	1.63	13	11.50
12000:120V	15.5kV	80,000	0.5E	1.63	13	11.50
13200:120V	15.5kV	80,000	0.5E	1.63	13	11.50
14200:120V	15.5kV	80,000	0.5E	1.63	13	11.50

- Primary terminals that are unfused are 1/4-20 brass screws with one flatwasher and lockwasher.
- Primary terminals that are fused are 1/4-20 brass screws with one flatwasher and lockwasher and two nuts.
- Secondary terminals are No. 10-32 brass screws with one flatwasher and lockwasher.
- The core and coil assembly is vacuum encapsulated in polyurethane resin.
- Thermal burden rating is for 120 volt secondaries.
- Switch gear style is similar to fused style. No fuse or fuse clip is provide, but inserts for fuse clips are supplied.
- A test card is provided with each unit.

RECOMMENDED MINIMUM SPACINGS

A = Unit to Unit or to Ground = 1.25" minimum.

B = HV to Ground in air = 6.50" minimum.

Recommended spacing are for guidance only. User needs to set appropriate values to assure performance for high potential test, impulse test, high humidity, partial discharge, high altitude, and other considerations like configuration.

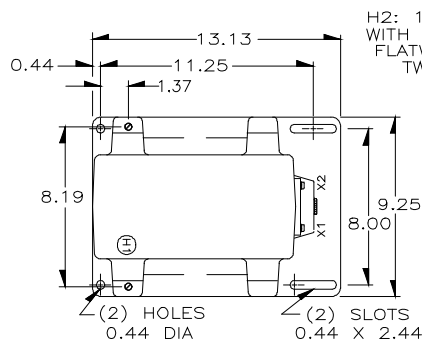
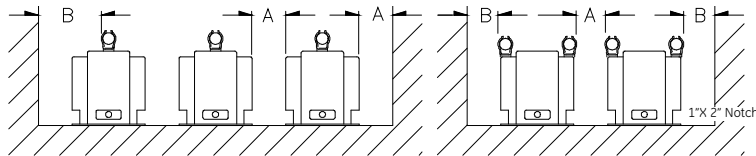

H2: 1/4-20 STUD WITH LOCKWASHER, FLATWASHER AND TWO NUTS

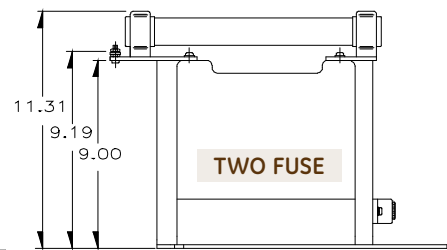
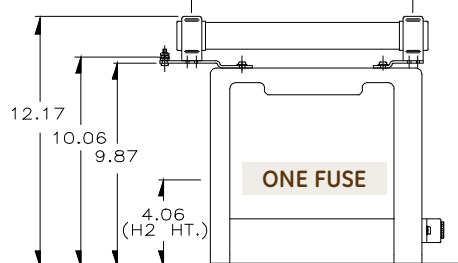
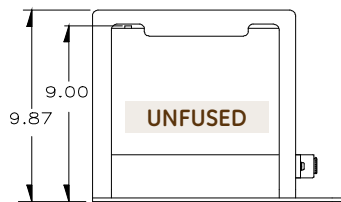
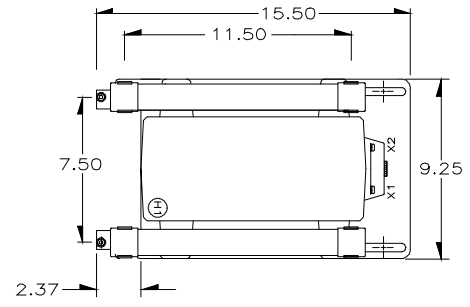
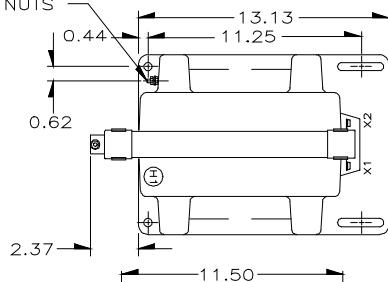

CIRCLE DIAGRAM

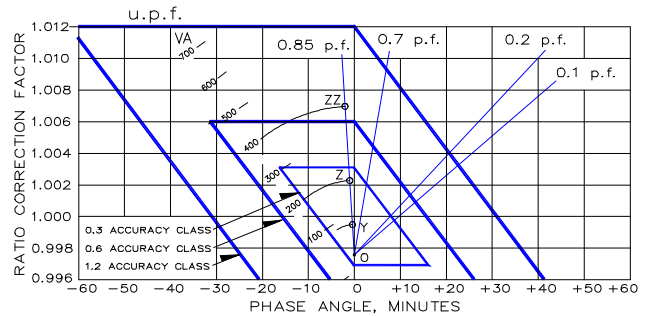

The circle diagram can be used to predict the performance of a transformer for various loads and power factors. A convenient scale of volt-ampere is shown on the unity power factor line (u.p.f.) and commences at the zero or no-load locus. To use the diagram, measure the known V.A. and scribe an arc about the "Zero" locus that contains the angle of the burden power factor. The point at which the arc terminates is the error locus in phase angle minutes and ratio correction factor.