





Installation and Operating Instructions

Integra Ci3

The following symbols appear in this user guide, and may also be affixed to the products discussed in this guide:

Symbol	Description
	Earth terminal
	Caution, Risk of electric shock
	Caution, Refer to accompanying text

Contents

1	Introduction	5
1.1	Unit Characteristics	5
1.2	Current Transformer Primary Current	5
1.3	RS485 Serial Option Modbus™ or JC N2Protocol.....	6
1.4	Pulse Output Option.....	6
2	Start Up Screens	7
3	Measurement Mode	8
3.1	Display Mode Screen Sequence.....	9
4	Setting-Up	10
4.1	Setup Entry Methods	10
4.1.1	Menu Option Selection.....	10
4.1.2	Number Entry Procedure	10
4.2	Setup Menu Structure	12
4.3	Change Password.....	13
4.4	Supply System	13
4.5	CT	14
4.6	Demand Integration Time	15
4.7	Reset.....	16
4.8	Communications	17
4.9	Relay Pulse Output	22
4.10	Energy Units	26
4.11	Test	27
4.12	Version Information	29
5	Specification	30
5.1	Measurement Inputs	30
5.1.1	Range of Use	30
5.2	Accuracy	30
5.3	Auxiliary Supply	31
5.4	Option Modules.....	31
5.4.1	Pulse Relay Outputs	31
5.4.2	RS485 Output for Modbus™ or JC N2 Protocol	31
5.5	Reference Conditions of Influence Quantities.....	32
5.6	Environment.....	32
5.7	Mechanics.....	32
5.8	Approval, Certification, and Standards Compliance.....	32
6	Maintenance	33
7	Installation	33

7.1	Safety	33
7.2	EMC Installation Requirements.....	33
7.3	Case Dimensions and Panel Cut-Out	34
7.4	Wiring	35
7.5	Additional considerations for three wire systems	35
7.6	Auxiliary Supply.....	35
7.7	Fusing.....	35
7.8	Earth/Ground Connections.....	36
7.9	Connection Diagrams.....	36
7.10	RS485 and Modbus™ or JC N2 Protocol.....	36
7.11	Operation Check	37
8	Basis of measurement and calculations	37
8.1	Phase to Phase voltages.....	37
8.2	Reactive and Apparent Power.....	37
8.3	Energy resolution	37
8.4	Power Factor	37
8.5	Maximum Demand	38
8.6	Total Harmonic Distortion.....	38
9	Glossary	39
10	Index	40

1 Introduction

This document provides operating, maintenance and installation instructions for the Crompton Instruments Integra Ci3 digital meter. The unit measures and displays all major electrical and power quality parameters, including imported real and reactive energy, since it was last reset, in terms of Wh, kWh, MWh, VARh, kVARh and MVARh for single phase, three-phase 3-wire or three-phase 4-wire supplies. In order to measure these parameters, the unit requires voltage and current inputs in addition to the supply required to power the unit. The current input(s) are obtained via current transformers (CTs).

The unit can be configured to work with a wide range of CTs, giving the unit a wide range of operation. Option modules can be fitted to provide pulse and RS485 Modbus™/JC N2 outputs. Configuration is password-protected.

The unit can be powered from a separate auxiliary a.c. (or d.c.). Alternatively it can be powered from the monitored supply, where appropriate.

1.1 Unit Characteristics

- Individual Line-to-Neutral (4-wire and 2-wire only) and Line-to-Line voltages
- Line frequency
- Individual line voltage % THD
- Individual line currents
- Neutral current (calculated)
- Individual line current maximum demand
- Individual line current % THD
- Active Power
- Reactive Power
- Apparent Power
- Maximum Active Power Demand
- Power Factor
- Active Energy (Wh, kWh or MWh)
- Reactive Energy (VARh, kVARh or MVARh)

The unit has password-protected set-up screens for:

- Changing password
- System type selection
- CT primary current (1 to 9999A)
- Demand interval time
- Energy reading reset
- Pulse output duration and rate divisor (option)
- RS485 serial Modbus™ or JC N2 format (option)

Pulsed relay outputs, indicating energy, and an RS485 output are available as optional extras. The RS485 output option allows remote monitoring from another display or a computer.

1.2 Current Transformer Primary Current

The unit can be configured to operate with CT primary current of between 1 and 9999A. Maximum CT primary current corresponds to a maximum input current to the unit of 5A.

1.3 RS485 Serial Option Modbus™ or JC N2Protocol

This option uses an RS485 serial port with Modbus™ or Johnson Controls (JC) N2 protocol to provide a means of remotely monitoring the Ci3 unit. Both protocols are supported in the same unit. Full instructions for RS485 port can be found in Section 4.8.

1.4 Pulse Output Option

This option provides one or two relay pulse outputs that clock up measured active (Wh) or reactive (VARh) energy. The unit can produce one pulse for preset quantity of energy imported. Pulse rate divisor and width are configured from the Set-up menu, as detailed in Section 4.9.



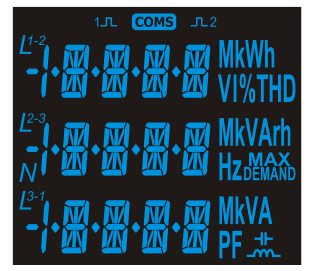
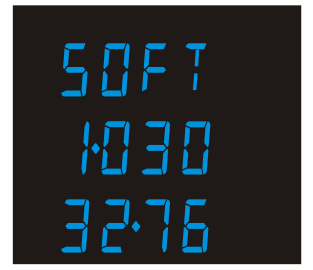
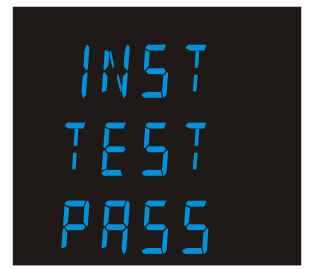



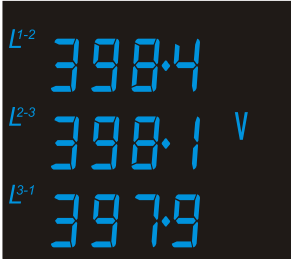

2 Start Up Screens

	<p>The first screen lights all LED segments and can be used as a display LED check.</p>
	<p>The second screen indicates the hardware and firmware revision of the unit. This example shows a hardware revision of 1.030 and a firmware version number of 32.76.</p>
	<p>Next the unit performs a self-test and the screen indicates if the test is passed.</p>

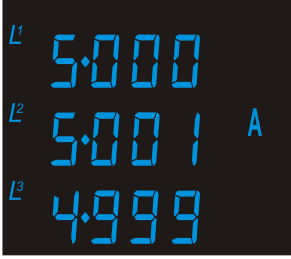



After a short delay, the default measurement screen appears.

3 Measurement Mode

In measurement mode, the buttons control the displayed measurement as follows:

		<p>Pressing this button cycles the display through the available Voltage and Frequency parameter screens. The specific parameters displayed are determined by the selected System Type (Three-Phase Three-Wire, Three-Phase Four-Wire, or Single-Phase Two Wire), see Section 3.1.</p>
		<p>Pressing this button cycles the display through the available Current parameter screens. Specific parameters displayed are determined by the selected System Type.</p>
		<p>This key is used to select and cycle through the System Power and Power Factor parameter screens.</p>
		<p>Cycles between Active import and Reactive import energy screens. The number displayed is split over two lines. In this example the active energy displayed is 0000092.5 kWh.</p> <p>The  and/or  symbol on the top line flashes each time an output pulse is generated.</p>

3.1 Display Mode Screen Sequence



	3 Phase 4 Wire		3 Phase 3 Wire		1 Phase 2 Wire	
	Screen	Screen	Screen	Parameters	Screen	Parameters
	1	Volts L1 – N Volts L2 – N Volts L3 – N	1	Volts L1 -L2 Volts L2 - L3 Volts L3 - L1	1	Volts L1 - -
	2	Volts L1 -L2 Volts L2 - L3 Volts L3 - L1				
	3	Frequency	2	Frequency	2	Frequency
	4	Volts L1 - N THD% Volts L2 - N THD% Volts L3 - N THD%				
	5	Volts L1 -L2 THD% Volts L2 - L3 THD% Volts L3 - L1 THD%	3	Volts L1 -L2 THD% Volts L2 - L3 THD% Volts L3 - L1 THD%	3	Volts L1 THD% - -
	1	Current L1 Current L2 Current L3	1	Current L1 Current L2 Current L3	1	Current L1 - -
	2	Neutral Current				
	3	L1 Current Max Demand L2 Current Max Demand L3 Current Max Demand	2	L1 Current Max Demand L2 Current Max Demand L3 Current Max Demand	2	L1 Current Max Demand - -
	4	Neutral Current Max Demand				
	5	Current L1 THD% Current L2 THD% Current L3 THD%	3	Current L1 THD% Current L2 THD% Current L3 THD%	3	Current L1 THD% - -
	1	kW kVAr kVA	1	kW kVAr kVA	1	kW kVAr kVA
	2	kW Max Demand	2	kW Max Demand	2	kW Max Demand
	3	Power Factor	3	Power Factor	3	Power Factor
	1	kWh	1	kWh	1	kWh
	2	kVArh	2	kVArh	2	kVArh



The top line of the screen displays  and/or  symbols, which flash each time an output pulse is generated. Additionally, a  symbol will flash to show RS485 activity.

4 Setting-Up

Setting up of the Integra Ci3 digital meter may be carried out by using either the Integra Ci3 digital meter Configurator software. The Integra Configurator software is available in the online guide, which can be downloaded from www.crompton-instruments.com. Alternatively, if required, setting up parameters may be manipulated directly via the RS485 interface. The following sections give step-by-step procedures for configuring the digital meter using the front panel.













To enter set-up mode, firmly press the  and  buttons simultaneously and hold for approximately 5 seconds, until the password screen appears. Setting-up is password-protected so you must enter the correct password (default '0000') before proceeding. If an incorrect password is entered, the display reverts to measurement mode.

To exit setting-up mode, press  repeatedly until the measurement screen is restored or hold  and  buttons simultaneously for 5 seconds.

4.1 Setup Entry Methods



Some menu items, such as password and CT, require a four-digit number entry while others, such as supply system, require selection from a number of options.



4.1.1 Menu Option Selection

1. Use the  (up) and  (down) keys to select the required item from the menu shown in Section 4.2. Selection does not roll over from bottom to top of list or vice versa.
2. Press  (enter) key to confirm your selection.
3. If an item flashes (shown **red** on these pages), then it can be adjusted by the  and  keys. If not, there may be a further layer, e.g. Comms - Baud rate, before adjustment is possible. Press  to select the lower layer.
4. Having selected an option from the current layer, press  to confirm your selection. The bottom row will indicate SET to confirm the value has been set to the desired value.
5. Having completed a parameter setting, press  (back) to return to a higher menu level. The SET indicator will extinguish and you can then use the  and  keys for further menu selection.
6. On completion of all setting-up, repeatedly press  to return to the measurement screen.

4.1.2 Number Entry Procedure

When setting-up the unit, some screens require the entering of a number. In particular, on entry to the setting-up section, a password must be entered. Digits are set individually, from left to right. The procedure is as follows:







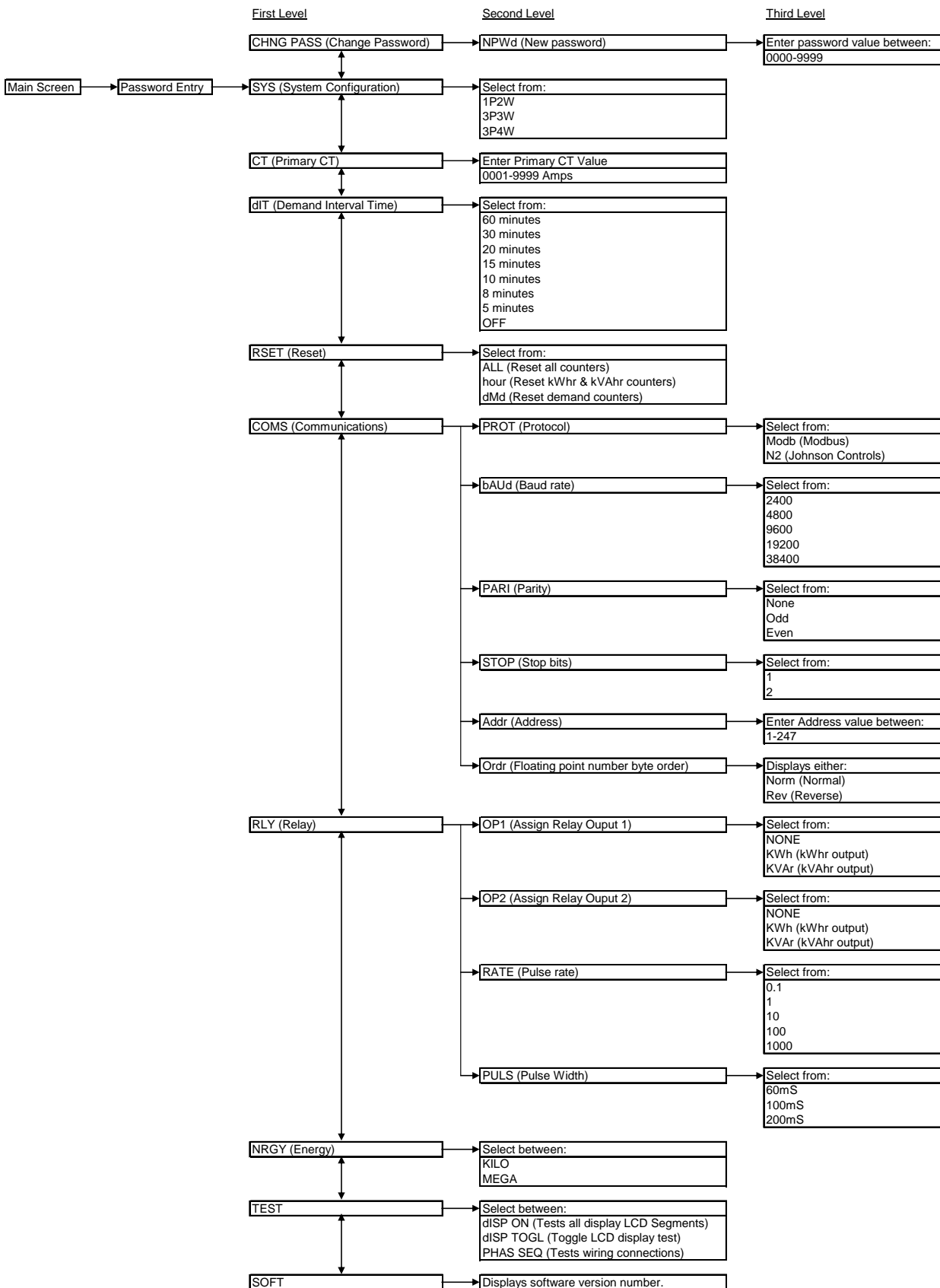



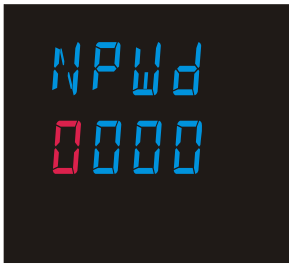

1. The current digit to be set flashes (shown **red** on these pages) and is set using the  and  keys.

2. Press  to confirm each digit setting. The SET indicator comes on to confirm successful entry after the last digit has been set.
3. To step back a digit, to correct a mistake, press the  key.
4. After setting the last digit, press  to exit the number setting routine. The SET indicator will extinguish.

4.2 Setup Menu Structure







4.3 Change Password

1.	Use  and  to choose the Change Password option.	
2.	Press  to enter the change password routine. The New Password screen will appear with the first digit flashing.	
3.	Use  and  to set the first digit and press  to confirm your selection. The next digit will flash.	
4.	Repeat the procedure for the remaining three digits.	
5.	At any point during the number entry procedure, press  to step back a digit or, by repeated pressing, step back out of the Change Password screen without saving your changes.	
6.	After setting the last digit, the SET indicator will light.	
7.	Press  to exit the number setting routine and return to the Set-Up menu. The SET indicator will extinguish.	

4.4 Supply System



Use this section to set the system type of the supply being monitored.



1.	From the Set-up menu, use the  and  keys to select the System option. The screen will show the currently selected system type.	
----	--	---

<p>2.</p>	<p>Press  to enter the Supply Selection routine.</p>	
<p>3.</p>	<p>Use the  and  keys to select the required system type:</p> <div style="display: flex; justify-content: space-around; align-items: flex-end;"> <div style="text-align: center;">  <p>3-phase 4-wire</p> </div> <div style="text-align: center;">  <p>3-phase 3-wire</p> </div> <div style="text-align: center;">  <p>single phase</p> </div> </div>	
<p>4.</p>	<p>Press  to confirm your selection. SET indicator will appear.</p>	
<p>5.</p>	<p>Press  to exit the system selection routine and return to the menu. The SET indicator will extinguish and you will be returned to the main Set-up menu.</p>	

4.5 CT



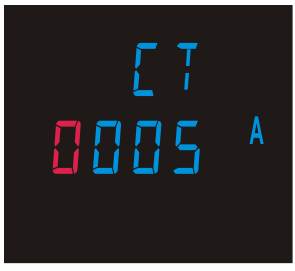



The CT option sets the maximum primary current of the current transformer (CT) that will give 5A into the meter (the maximum).

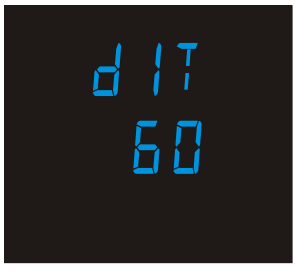

<p>1.</p>	<p>From the Set-up menu, use the  and  keys to select the CT option. The screen will show the current CT primary current value. An 'A' to the right indicates that the reading is in Amperes.</p>	
-----------	---	---

2.	Press  to enter the CT routine. The first digit will flash.	
3.	Use the method described in Section 4.1.2 to set the 4-digit number to the maximum CT primary current, e.g. 500A.	
4.	On completion of the entry procedure, press  to return to the main Set-up menu.	

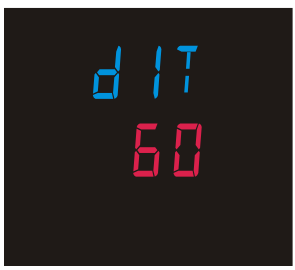
4.6 Demand Integration Time



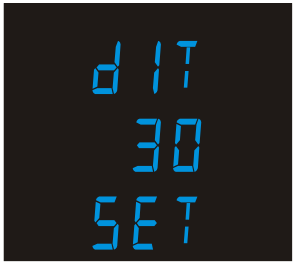

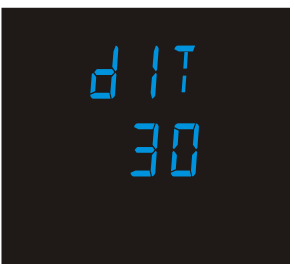











The Demand Integration Time (dIT) option sets the period over which the current and power readings are integrated for maximum demand measurement.



1.	From the Set-up menu, use the  and  keys to select the dIT option. The screen will show the current demand integration time, in minutes.																	
2.	Press  to enter the demand integration time routine.																	
3.	Use the  and  keys to select the required integration time: <table data-bbox="542 1702 1021 1971"> <tr><td>60</td><td>60 minutes</td></tr> <tr><td>30</td><td>30 minutes</td></tr> <tr><td>20</td><td>20 minutes</td></tr> <tr><td>15</td><td>15 minutes</td></tr> <tr><td>10</td><td>10 minutes</td></tr> <tr><td>8</td><td>8 minutes</td></tr> <tr><td>5</td><td>5 minutes</td></tr> <tr><td>OFF</td><td>No demand integration time</td></tr> </table>	60	60 minutes	30	30 minutes	20	20 minutes	15	15 minutes	10	10 minutes	8	8 minutes	5	5 minutes	OFF	No demand integration time	
60	60 minutes																	
30	30 minutes																	
20	20 minutes																	
15	15 minutes																	
10	10 minutes																	
8	8 minutes																	
5	5 minutes																	
OFF	No demand integration time																	

4.	Press  to confirm your selection. SET indicator will appear.	
5.	Press  to return to the main Set-up menu.	

4.7 Reset

Use this option to reset Demand (dMd) and Energy (kWh, kVArh) measurements, either individually or all together, to zero.

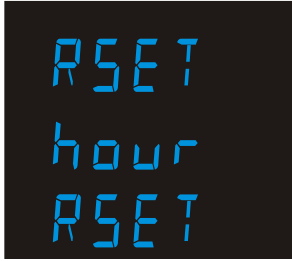





1.	From the main Setup menu, use the  and  keys to select the Reset option.							
2.	Press  to enter the Reset sub-menu. The dMd segment will flash.							
3.	Using the  and  keys, select which parameter you wish to reset:							
<table style="width: 100%; text-align: center;"> <tr> <td data-bbox="209 1610 501 1865"></td> <td data-bbox="547 1610 839 1865"></td> <td data-bbox="885 1610 1177 1865"></td> </tr> <tr> <td data-bbox="236 1865 474 1899">Demand counters</td> <td data-bbox="528 1865 858 1899">kWh and kVArh counters</td> <td data-bbox="951 1865 1110 1899">All counters</td> </tr> </table>						Demand counters	kWh and kVArh counters	All counters
								
Demand counters	kWh and kVArh counters	All counters						







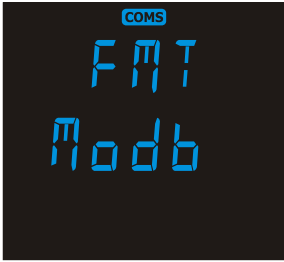



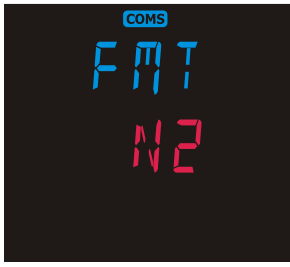

4.	Press  to reset the selected parameter. RSET will be displayed and the chosen parameter will stop flashing.	
5.	Press  to exit the Reset routine. RSET will extinguish and you will be returned to the main Set-up menu.	

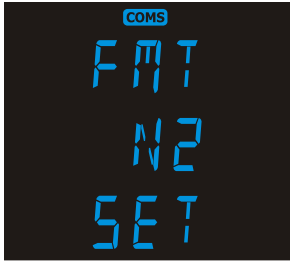
4.8 Communications



The RS485 port can be used for communications using either Modbus™ or Johnson Controls (JC) N2 protocol. For Modbus™, parameters such as Baud rate are selected from the front panel whereas for JC N2 they are fixed. The RS485 address can be selected for both protocols.









The first section allows you to select either Modbus™ or JC N2 configuration.

1.	From the main Setup menu, use the  and  keys to display the Communications screen.	
2.	Press  . The Format screen will appear showing the current format – ModB or N2.	
3.	To change the format, press  . The format will flash.	

4.	Use the  and  key to change the format.	
5.	Press  to confirm your selection. SET will be displayed.	
6.	Press  to exit the format selection routine. The SET indicator will extinguish.	
<p>If you have selected N2 format, you can use the  and  keys to select the RS485 address option and set it as detailed on page 21.</p> <p>If you have selected Modb format, set the serial parameters as follows:</p>		
7.	Use the  and  keys to cycle through the Baud, parity, stop bits and address menu options.	





Baud Rate (not applicable for JC N2)









8.	To change the Baud setting, ensure that the display shows the Baud setting and press  to enter the Baud setting routine. The setting digits will flash.	
----	--	---

9.	Use the  and  keys to select the desired Baud rate from the available options 9600, 4800, 2400, 38.4k (38400) and 19.2k (19200).	
10.	Press  to confirm your Baud rate selection. SET will be displayed.	
11.	Press  to exit Baud setting routine. The SET indicator will extinguish and the  and  keys can be used to select a different communications parameter.	

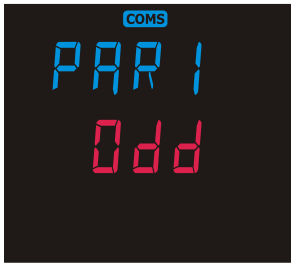
Parity (not applicable for JC N2)





Note that if parity is set to Odd or Even, Stop Bits will be set to 1 and cannot be changed.









12.	Use the  and  keys to select the Parity option.	
13.	Press  to enter the parity setting routine. The parameter will flash.	

<p>14.</p>	<p>Use the  and  keys to select the desired parity option from None, Even and Odd.</p>	
<p>15.</p>	<p>Press  to confirm your selection. SET will be displayed.</p>	
<p>16.</p>	<p>Press  to exit parity setting routine. The SET indicator will extinguish and the  and  keys can be used to select a different communications parameter.</p>	

Stop Bits(not applicable for JC N2)

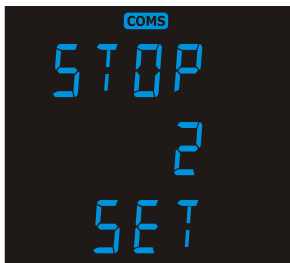

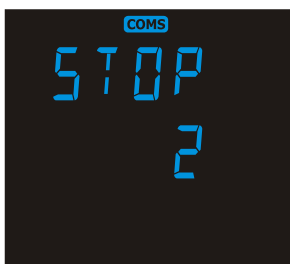

Note that, if Parity is set to Odd or Even, Stop Bits will be set to 1 and cannot be changed.

<p>17.</p>	<p>Use the  and  keys to select the Stop Bits option.</p>	
<p>18.</p>	<p>Press  to enter the Stop Bits setting routine. The parameter value will flash.</p>	

19.	Use the  and  keys to select either 1 or 2 stop bits.	
20.	Press  to confirm your selection. SET will be displayed.	
21.	Press  to exit Stop Bits setting routine. The SET indicator will extinguish and the  and  keys can be used to select a different communications parameter.	

RS485 Address

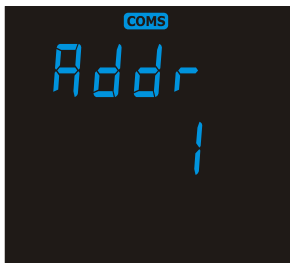
An RS485 network can accommodate up to 255 different devices, each identified by an address between 1 and 247 (Modbus™) or 1 and 255 (JC N2).

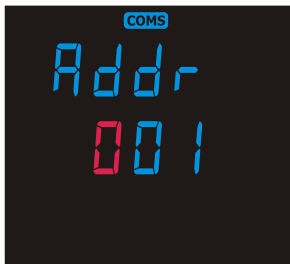
22.	Use the  and  keys to select the Address option.	
23.	Press  to enter the Address setting routine. The first digit will flash.	
24.	Use the method described in Section 4.1.2 to set the 3-digit address to the required number between 1 and 247 for Modbus™ or 1 and 255 for JC N2.	

Modbus™ Word Order (not applicable for JC N2)

This screen shows the word order (Hi/Lo) of the 8-bit bytes in the Modbus™ message format. Normal is Hi first. This screen is for information purposes only, as this setting cannot be changed from the front panel. (Not applicable for JC N2 format.)

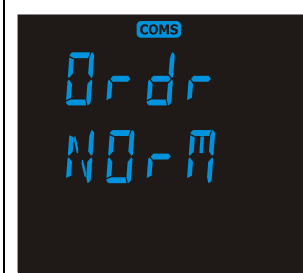

Press  to exit the Communications set-up screens and return to the main Set-up menu.





4.9 Relay Pulse Output



This option allows you to configure one or two optional pulse outputs from the unit. Each output can be set to provide a pulse for a defined amount of energy imported. The energy monitored can be active or reactive and the pulse width can be select as 200, 100 or 60 ms. The defined energy per pulse will be the same for both outputs.

Maximum output pulse rate is two pulses per second, and the system prohibits setting of an energy-per-pulse that will give a pulse rate greater than this. For example, on a single-phase, two-wire system, a CT setting of 900A with a maximum 289V supply with 120% overload on both current and voltage implies a maximum energy imported in an hour of $(900 \times 120\%) \times (289 \times 120\%) = 375 \text{ kWh}$ which is 104 W.seconds. A setting of 10Wh per pulse would generate 10 pulses per second. Since this exceeds 2/s, the unit would not allow such a setting.













Use this section to set up the relay pulse output(s) –

- Output 1** off, import kWh, import kVArh
- Output 2** off, import kWh, import kVArh
- Rate** (for both) 0.001/0.01/0.01/0.1/1/10/100/1000/10,000 kilo/pulse
- Pulse width** (for both) 200/100/60 ms.

<p>1.</p>	<p>From the main Setup menu, use the  and  keys to display the Relay screen.</p>	
<p>2.</p>	<p>Press . The Output 1 screen will appear.</p>	

From here, the  and  keys can be used to select menus for Output 1, Output 2, Rate and Pulse Width.

Output 1













3.	Use the  and  keys to select the Output 1 screen.	
4.	Press  to enter the Output 1 setting routine. The screen will show the current setting for Output 1 flashing.	
5.	Use the  and  keys to select the required option for Output 1: None, kVAr, or kWh.	
6.	Press  to confirm your selection. The SET indicator will appear.	
7.	Press  to exit Output 1 setting routine. The SET indicator will extinguish and the  and  keys can now be used to select a different Relay parameter.	

Output 2

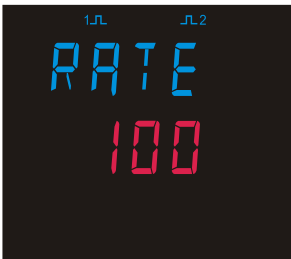
This is the next item on the Relay menu and the method of setting is exactly the same as for Output 1.

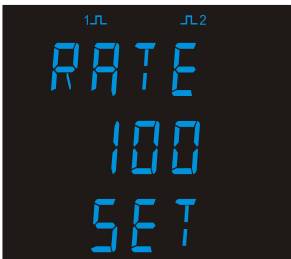













Rate

Use this to set the energy represented by each pulse from either output.

8.	Use the  and  keys to select the Rate screen.	
9.	Press  to enter the Rate setting routine. The Rate value will flash. The Rate is the energy that each output pulse represents.	
10.	Use the  and  keys to select the Rate required for the pulse output(s).	
11.	Press  to confirm your selection. The SET indicator will appear and the display will stop flashing.	
12.	Press  to exit Rate setting routine. The SET indicator will extinguish and the  and  keys can be used to select a different Relay parameter.	

Pulse Duration

Use this option to set the duration of pulses (in ms) from both outputs.













13.	Use the  and  keys to select the Pulse screen.	
14.	Press  to enter the Pulse Width setting routine. The value will flash.	
15.	Use the  and  keys to select the Pulse Width in ms.	
16.	Press  to confirm your selection. The SET indicator will appear and the display will stop flashing.	
17.	Press  to exit Pulse Width setting routine. The SET indicator will extinguish and the  and  keys can be used to select a different Relay parameter.	

Press  to exit the Relay set-up screens and return to the main Set-up menu.

4.10 Energy Units









Use this option to set the displayed units multiplier.

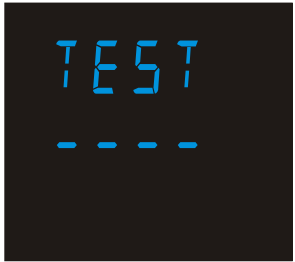

The unit multiplier for all displays can be set to kWh/kVArh (kilo) or MWh/MVArh (Mega).

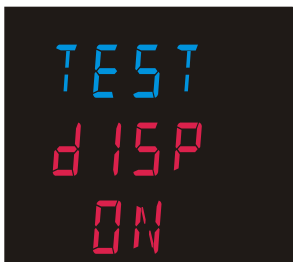
1.	Use the  and  keys to select the Energy screen. The screen will show the energy unit in use.	
2.	Press  to enter the Energy unit selection routine. The current selected unit flashes.	
3.	Use the  and  keys to select the desired unit.	
4.	Press  to confirm your selection. The SET indicator will appear and the display will stop flashing.	
5.	Press  to exit Unit setting routine. The SET indicator will extinguish.	

4.11 Test

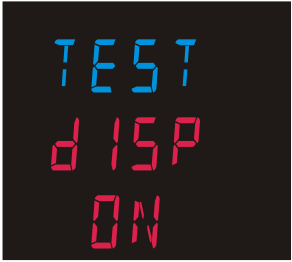
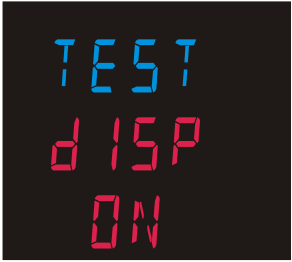
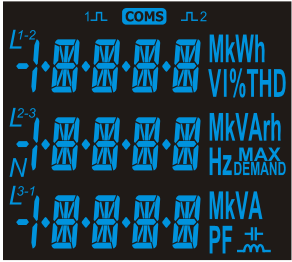
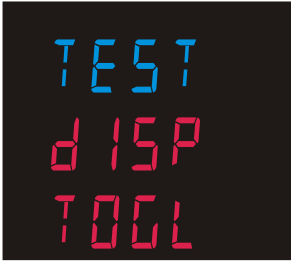
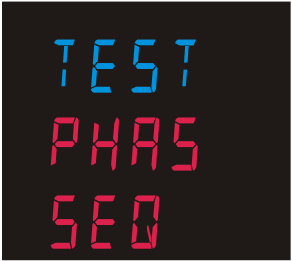
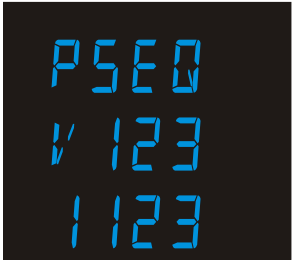
This option provides various test facilities.

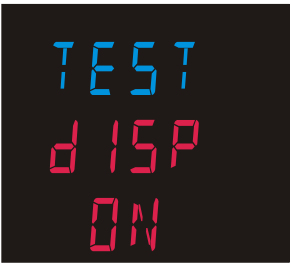
<p>1.</p>	<p>Use the  and  keys to select the Test screen.</p>	
<p>2.</p>	<p>Press  to enter the Test menu.</p>	
<p>3.</p>	<p>Use the  and  keys to select the required test option and press  to confirm your selection. The available options are:</p>	
	<p>Lights all LCD segments so that display segments can be checked.</p>	
	<p>Toggles display segments alternately.</p>	
	<p>Shows the voltage and current phase sequences.</p>	

4.	Press  to exit the selected test display mode.	
5.	Press  again to return to the main Setup menu.	

The voltage and current inputs must be greater than 5% of nominal for the test to operate reliably.

Voltage and current phase displays show the phase relationships of the inputs. To obtain the correct power readings, the phase sequences can be either '123' or '132' but must be the same for both current and voltage.

To obtain phase indications, the measured phase relationships must be within the following parameters. If, for instance, a current transformer were to be reverse connected, the phase of the measured current for that phase would be out by 180° and the display would indicate a current phase error.

Three-phase four-wire mode

Measurements are referenced from L1.

Voltage:

For the voltage sequence test, the phase of L2 relative to L1 must be within the window $240^\circ \pm 48^\circ$ and L3 relative to L1 must be within the window $120^\circ \pm 48^\circ$ to record the sequence V123.

Alternatively, the phase of L2 relative to L1 must be within the window $120^\circ \pm 48^\circ$ and L3 relative to L1 must be within the window $240^\circ \pm 48^\circ$ to record the sequence V132.

The display shows 'V1--' if a voltage phase is outside these parameters.

Current:

For the current sequence test, the phase of I1 relative to L1 must be within the window $0^\circ \pm 48^\circ$, I2 relative to L1 must be within the window $240^\circ \pm 48^\circ$, and I3 relative to L1 must be within the window $120^\circ \pm 48^\circ$ to record the sequence i123.

Alternatively the phase of I1 relative to L1 must be within the window $0^\circ \pm 48^\circ$, I2 relative to L1 must be within the window $120^\circ \pm 48^\circ$, and I3 relative to L1 must be within the window $240^\circ \pm 48^\circ$ to record the sequence i132.

The display shows 'I --' if a current phase is outside these parameters.

Three-phase three-wire mode

Measurements are referenced from L1-L2.

Voltage:

For the voltage sequence test, the phase of L2-L3 relative to L1-L2 must be within the window $240^\circ \pm 48^\circ$ and L3-L1 relative to L1-L2 must be within the window $120^\circ \pm 48^\circ$ to record the sequence V123.

Alternatively, the phase of L2-L3 relative to L1-L2 must be within the window $120^\circ \pm 48^\circ$ and L3 relative to L1-L2 must be within the window $240^\circ \pm 48^\circ$ to record the sequence V132.

The display shows 'V1--' if a voltage phase is outside these parameters.

Current:

For the current sequence test, the phase of I1 relative to L1-L2 must be within the window $330^\circ \pm 48^\circ$, I2 relative to L1-L2 must be within the window $210^\circ \pm 48^\circ$, and I3 relative to L1-L2 must be within the window $90^\circ \pm 48^\circ$ to record the sequence i123.

Alternatively, the phase of I1 relative to L1-L2 must be within the window $330^\circ \pm 48^\circ$, I2 relative to L1-L2 must be within the window $90^\circ \pm 48^\circ$, and I3 relative to L1-L2 must be within the window $210^\circ \pm 48^\circ$ to record the sequence i132.

The display shows 'I--' if a current phase is outside these parameters.

Information

The setup menu shows the firmware and hardware build version of the unit.

This example shows a hardware version of 1-030 and a firmware version of 32-76.

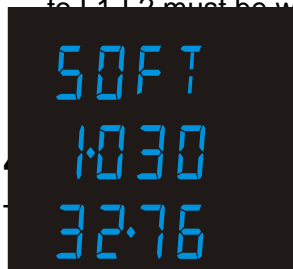

5 Specification

5.1 Measurement Inputs

Imported energies are recorded.

3-Phase 4-Wire, 3-Phase 3-Wire and Single-Phase 2-Wire Unbalanced.

Direct measurement of 173 to 500Vac L-L, (100 to 289Vac L-N).

Line frequency measured from L1 voltage or L3 voltage.

Three current inputs (six physical terminals) for connection of external CTs.

5.1.1 Range of Use

Values of measured quantities, components of measured quantities, and quantities which affect measurement errors to some degree, for which the product gives meaningful readings.

Voltage 5 ... 120% of Range Maximum (below 5% of Range Maximum voltage, current indication may only be approximate)

Current 1 ... 120% of nominal

Active power 1 ... 144% of nominal, 360MW maximum

Apparent power 1 ... 144% of nominal, 360MVA maximum

Power is only registered when voltage and current are within their respective range of use.

5.2 Accuracy

Voltage (V) 0.5% of range maximum

Current (A) 0.5% of range maximum (4% for I2 in three wire mode)

Neutral Current calculated (A) 4% of range maximum

Frequency (Hz) 0.11Hz

Power factor (PF) 1% of unity

Active power (W) $\pm 1\%$ of range maximum

Reactive power (VAR) $\pm 1\%$ of range maximum

Apparent power (VA) $\pm 1\%$ of range maximum

Active energy (Wh) Class 1 IEC 62053-21 Section 4.6

Reactive energy (VARh) $\pm 1\%$ of range maximum

THD 1% up to 31st harmonic

Response time to step input 1 second typical to >99% of final value

Temperature co-efficient Active energy = 0.018%/°C, typical

Error change due to variation of an influence quantity in the manner described in Section 6 of IEC 688:1992 $2 \times$ error allowed for the reference condition applied in the test. Error due to temperature variation as above.

Error in measurement when a measurand is within its measuring range, but outside its reference range

$2 \times$ error allowed at the end of the reference range adjacent to the section of the measuring range, where the measurand is currently operating / being tested.

5.3 Auxiliary Supply

The unit can be powered from an auxiliary a.c. or d.c. supply that is separate from the metered supply. Two-way fixed connector with 2.5mm² stranded wire capacity.

110 to 400V a.c. 50/60Hz $\pm 10\%$ or 120V to 350V d.c. $\pm 20\%$. Consumption 5VA nominal.

5.4 Option Modules

Up to two option modules can be fitted which can be of two types: a single RS485 (Modbus™ / JC N2) or single pulse relay output. A fully populated product can support one RS-485 channel and one pulse relay output or two pulse relay outputs.

5.4.1 Pulse Relay Outputs

These outputs can be configured from the Set-up menu.

Each of the two possible outputs can be set to generate pulses representing imported kWh or kVArh.

Rate can be set to generate 1 pulse per

0.001	= 1 Wh/VArh
0.01	= 10 Wh/VArh
0.1	= 100 Wh/VArh
1	= 1 kWh/kVArh
10	= 10 kWh/kVArh
100	= 100 kWh/kVArh
1000	= 1 MWh/MVArh
10000	= 10 MWh/MVArh

The rate cannot be set to a value that could result in more than 2 pulses/second.

Pulse width 200/100/60 ms.

5.4.2 RS485 Output for Modbus™ or JC N2 Protocol

For Modbus™, the following RS485 communication parameters can be configured from the Set-up menu:

- Baud rate 2400, 4800, 9600, 19200, 38400
- Parity none/odd/even
- Stop bits 1 or 2 (only 1 stop bit can be set if odd or even parity is required)
- RS485 network address *nnn* – 3-digit number 1 to 247

For JC N2, only the RS485 network address can be configured. The range of addresses is 1-255.

5.5 Reference Conditions of Influence Quantities

Influence Quantities are variables that affect measurement errors to a minor degree. Accuracy is verified under nominal value (within the specified tolerance) of these conditions.

Ambient temperature	23°C ±1°C
Input waveform	50 or 60Hz ±2%
Input waveform	Sinusoidal (distortion factor < 0.005)
Auxiliary supply voltage	Nominal ±1%
Auxiliary supply frequency	Nominal ±1%
Auxiliary supply waveform (if AC)	Sinusoidal (distortion factor < 0.05)
Magnetic field of external origin	Terrestrial flux

5.6 Environment

Operating temperature	-10°C to +55°C*
Storage temperature	-20°C to +70°C*

*Maximum operating and storage temperatures are in the context of typical daily and seasonal variation.

Relative humidity	0 to 90%, non-condensing
Altitude	Up to 2000m
Warm up time	1 minute
Vibration	10Hz to 50Hz, IEC 60068-2-6, 2g
Shock	30g in 3 planes

5.7 Mechanics

Dimensions	96 × 96 mm (L×W)
Depth (behind panel)	53 mm, 77.5mm with option module(s)
Case protrusion (in front of panel)	7 mm maximum
Sealing	IP52 (front panel), IP30 (case) (minimum)
Mounting	DIN 96 panel mounting

5.8 Approval, Certification, and Standards Compliance

RoHS compliant. (Although this class of product is presently excluded from the RoHS regulations, the unit has been designed and manufactured in compliance with the RoHS regulations.)

EMC Emissions	BS EN 61326, Class A (Industrial)
EMC Immunity	BS EN 61326, Class A (Industrial)
Safety	BS EN 61010-1:2001

6 Maintenance

In normal use, little maintenance is needed. As appropriate for service conditions, isolate electrical power, inspect the unit and remove any dust or other foreign material present. Periodically check all connections for freedom from corrosion and screw tightness, particularly if vibration is present.

The front of the case should be wiped with a dry cloth only. Use minimal pressure, especially over the viewing window area. If necessary wipe the rear case with a dry cloth. If a cleaning agent is necessary, isopropyl alcohol is the only recommended agent and should be used sparingly. Water should not be used. If the rear case exterior or terminals should be contaminated accidentally with water, the unit must be thoroughly dried before further service. Should it be suspected that water might have entered the unit, factory inspection and refurbishment is recommended.

In the unlikely event of a repair being necessary, it is recommended that the unit be returned to the factory or nearest Crompton Instruments / Tyco Electronics service centre.

7 Installation

The unit may be mounted in a panel of any thickness up to a maximum of 6 mm (0.25in). Leave enough space behind the instrument to allow for bends in the connection cables. As the front of panel enclosure conforms to IP52, it is protected from dripping water. The unit is intended for use in a reasonably stable ambient temperature within the range -10 to +55°C. Do not mount the unit where there is excessive vibration or in excessive direct sunlight.

7.1 Safety

The unit is designed in accordance with BS EN 61010-1:2001 (IEC 61010-1:2001) – Permanently connected use, Normal condition. Installation category III, pollution degree 2, basic insulation for rated voltage. Measurement Category III.

7.2 EMC Installation Requirements

Whilst this unit complies with all relevant EU EMC (electro-magnetic compatibility) regulations, any additional precautions necessary to provide proper operation of this and adjacent equipment will be installation dependent and so the following can only be general guidance:

- Avoid routing wiring to this unit alongside cables and products that are, or could be, a source of interference.
- The auxiliary supply to the unit should not be subject to excessive interference. In some cases, a supply line filter may be required.
- To protect the product against incorrect operation or permanent damage, surge transients must be controlled. It is good EMC practice to suppress transients and surges at the source. The unit has been designed to automatically recover from typical transients; however in extreme circumstances it may be necessary to temporarily disconnect the auxiliary supply for a period of greater than 10 seconds to restore correct operation.
- Screened communication leads are recommended and may be required. These and other connecting leads may require the fitting of RF suppression components, such as ferrite absorbers, line filters etc., if RF fields cause problems.
- It is good practice to install sensitive electronic instruments that are performing critical functions in EMC enclosures that protect against electrical interference causing a disturbance in function.



Warning

- During normal operation, voltages hazardous to life may be present at some of the terminals of this unit. Installation and servicing should be performed only by qualified, properly trained personnel abiding by local regulations. Ensure all supplies are de-energised before attempting connection or other procedures.
- Terminals should not be user accessible after installation and external installation provisions must be sufficient to prevent hazards under fault conditions.
- This unit is not intended to function as part of a system providing the sole means of fault protection - good engineering practice dictates that any critical function be protected by at least two independent and diverse means.
- The unit does not have internal fuses therefore external fuses must be used for protection and safety under fault conditions.
- Never open-circuit the secondary winding of an energized current transformer.
- This product should only be operated with CT secondary connections Earthed.
- If this equipment is used in a manner not specified by the manufacturer, protection provided by the equipment may be impaired.
- Auxiliary circuits (communication & relay outputs) are separated from metering inputs and 110-400V auxiliary circuits by at least basic insulation. Such auxiliary circuit terminals are only suitable for connection to equipment which has no user accessible live parts. The insulation for such auxiliary circuits must be rated for the highest voltage connected to the instrument and suitable for single fault condition. The connection at the remote end of such auxiliary circuits should not be accessible in normal use. Depending on application, equipment connected to auxiliary circuits may vary widely. The choice of connected equipment or combination of equipment should not diminish the level of user protection specified.

7.3 Case Dimensions and Panel Cut-Out

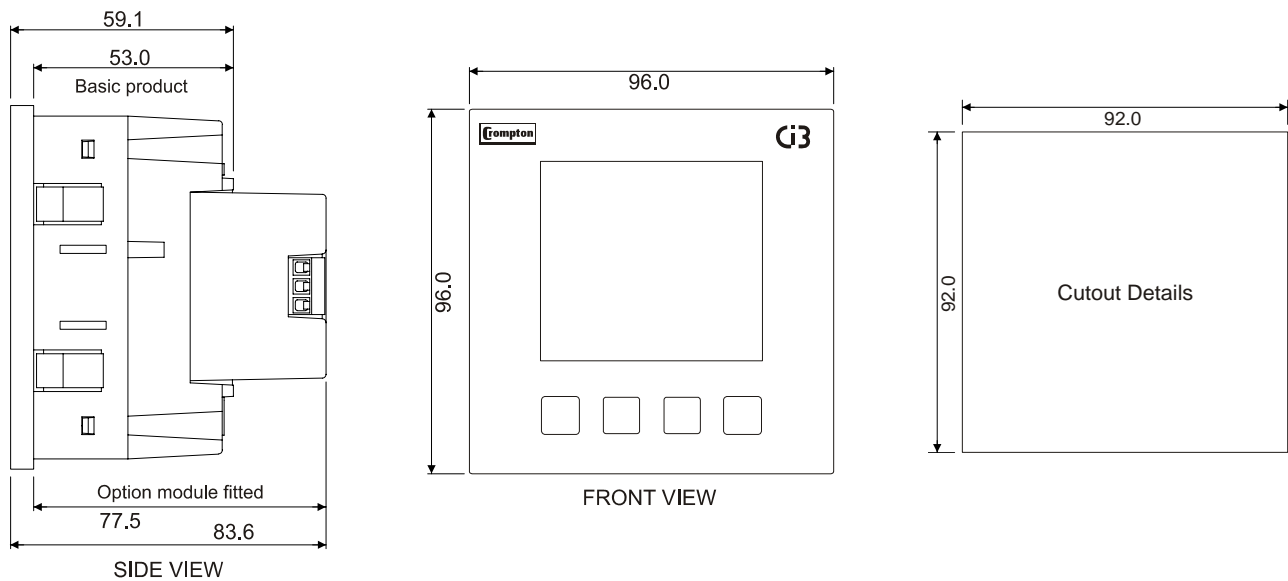

7.4 Wiring

Input connections are made to screw clamp terminals. Choice of cable should meet local regulations.

The current inputs of these products are designed for connection into systems via current transformers only.

Instrument transformers used for connection to the meter must be of approved type and compliant with ANSI/IEEE C57.13 or IEC 60044-1, selected and sized appropriate to the supply network being monitored.

To minimise measurement errors, the CTs should be grounded as shown in the wiring diagram in Section 7.9.

CT secondaries must be grounded in accordance with local regulations. It is desirable to make provision for shorting links to be made across CTs to permit easy replacement of a unit should this ever be necessary.

All negative current inputs are commoned inside the unit and grounding should be at one point only.

All connections are made to screw clamp terminals. Terminals are suitable for copper wires only and will accept one 0.05 – 2.5mm² (30 – 21AWG) stranded or solid core cable. This instrument is intended for panel mounting. Terminals must be enclosed within the panel. Use wire rated at 600V for main terminals, 60°C minimum temperature. Terminal screws are fully tightened for shipment and must be undone before wire insertion. Terminal screws should be tightened to 0.5Nm (4.4 lbf in) only.

7.5 Additional considerations for three wire systems

The neutral terminal (terminal N) is indirectly connected to the voltage input terminals (terminals L1, L2, L3). When connected to a three wire system the neutral terminal will adopt a potential somewhere between the remaining lines. If external wiring is connected to the neutral terminal it must be connected to either the neutral line or earth (ground) to avoid the possibility of electric shock from the neutral terminal.

7.6 Auxiliary Supply

The Integra Ci3 should ideally be powered from a dedicated supply. However, it may be powered from the signal source providing the source remains within tolerance for the auxiliary supply.

The unit can be powered from an auxiliary a.c. or d.c. supply that is separate from the metered supply.

110 to 400V a.c. 50/60Hz $\pm 10\%$ or 120V to 350V d.c. $\pm 20\%$. Consumption 5VA nominal.

7.7 Fusing

This unit must be fitted with external fuses in voltage and auxiliary supply lines. Voltage input lines must be fused with a fast blow fuse 1A maximum. Auxiliary supply lines must be fused with a slow blow fuse rated 1A maximum (if product is powered line-to-line, ensure both lines are fused). Choose fuses of a type and with a breaking capacity appropriate to the supply and in accordance with local regulations.

A suitable switch or circuit breaker conforming to the relevant parts of IEC 60947-1 and IEC 60947-3 should be included in the installation. It should be positioned so as to be easy to operate, in close proximity to the equipment, and clearly identified as the disconnecting device.

7.8 Earth/Ground Connections

For safety reasons, current transformer secondary connections should be grounded in accordance with local regulations. Under no circumstances should the product be operated without an Earth connection.

7.9 Connection Diagrams

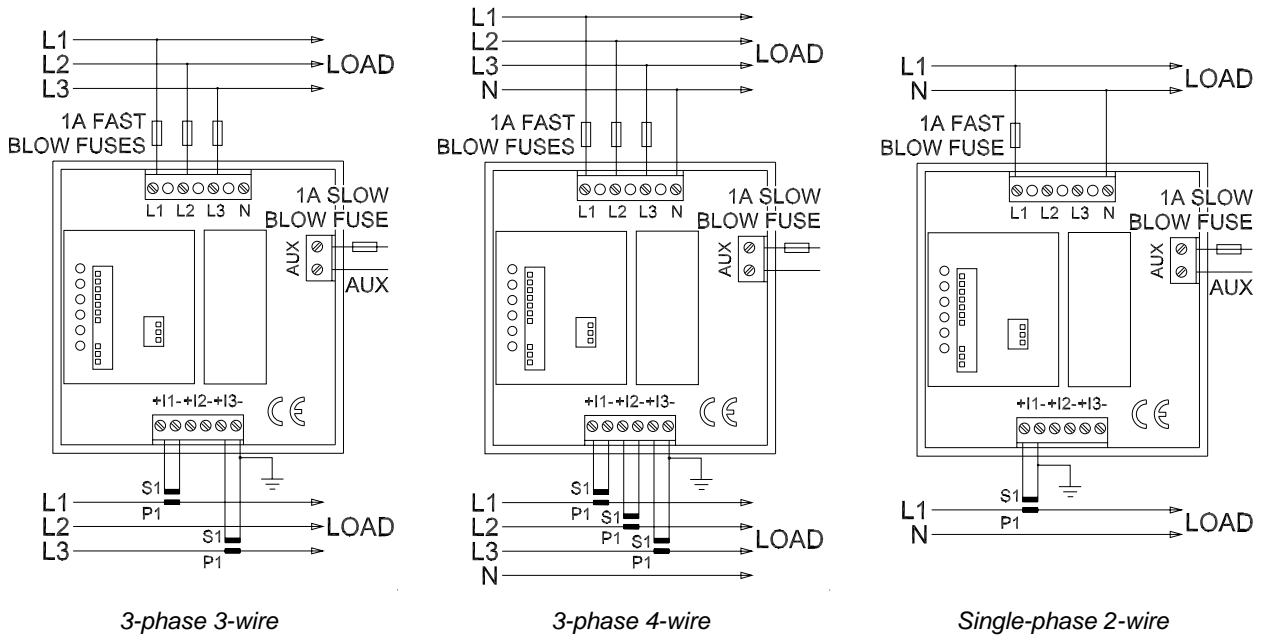

7.10 RS485 and Modbus™ or JC N2 Protocol

An optional RS485 module can be plugged into the rear of the Integra Ci3. RS485 in conjunction with the Modbus™ or JC N2 protocol allows the unit to be interrogated and provide a response detailing the readings it has taken. This can be used for remote monitoring by a PC or SCADA system.

An RS485 and Modbus™ Protocol Guide is available for download from the Crompton Instruments web site at http://www.crompton-instruments.com/downloads/Ri3_Ci1_Ci3_comms_guide_v1.pdf

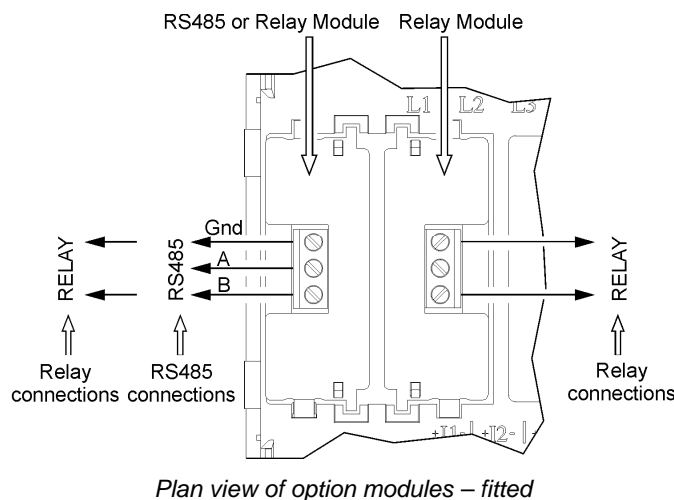

7.11 Operation Check

After installation, use the test display to check for incorrect wiring of the voltage and current transformer inputs. The displayed voltage (V) and current (I) sequences must be the same but can be '123' or '132'.

In the event of a voltage phase error, e.g. the same phase connected to two meter inputs, the display will show 'V1--'.

In the event of a current phase error, e.g. a current transformer reverse connected or connected to the wrong phase, the display will read 'I --'.

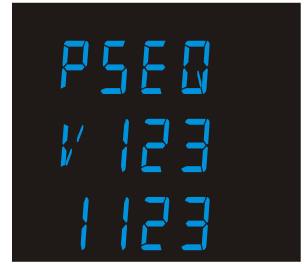

If the display shows an identical V and I sequence (123 or 132), check that the meter gives the correct forward and reverse indications. An incorrect forward/reverse indication means that all current transformer connections are reversed.

The meter has a defined tolerance for displaying phasing errors, see Section 4.11.

8 Basis of measurement and calculations

8.1 Phase to Phase voltages

Phase to Phase voltages are measured directly and calculated as RMS values. Situations where the phases are not spaced 120 degrees apart (e.g. 4 wire open delta) are indicated correctly.

8.2 Reactive and Apparent Power

Active powers are calculated directly by multiplication of voltage and current samples. Reactive powers are calculated using the frequency corrected quarter phase time delay method. Apparent power is calculated as the square root of the sum of the squares of active and reactive powers.

8.3 Energy resolution

Cumulative energy counts are reported using the standard IEEE floating point format. Reported energy values in excess of one million may show a small non cumulative error in the integer digits due to the limitations of the number format. Internally the count is maintained with greater precision. The reporting error is less than 1 part per million and is automatically corrected when the count increases.

8.4 Power Factor

The magnitude of Per Phase Power Factor is derived from the per phase active power and per phase reactive power. The power factor value sign is set to negative for an inductive load and positive for a capacitive load.

The magnitude of the System Power Factor is derived from the sum of the per phase active power and per phase reactive power. Individual phases whose apparent power is less than 3% of nominal are not included in power factor determinations. The system power factor value sign is set to negative for an inductive load and positive for a capacitive load. The load type, capacitive or inductive, is determined from the signs of the sums of the relevant active powers and reactive powers. If both signs are the same, then the load is inductive, if the signs are different then the load is capacitive. The magnitude of the phase angle is the ArcCos of the power factor. Its sign is taken as the opposite of the VAR's sign.

8.5 Maximum Demand

The maximum power consumption of an installation is provided as power utilities often levy related charges. Many utilities use a thermal maximum demand indicator (MDI) to measure this peak power consumption. An MDI averages the power consumed over a number of minutes, reflecting the thermal load that the demand places on the supply system. The Integra Ci3 digital meter uses a sliding window algorithm to simulate the characteristics of a thermal MDI instrument, with the demand period being updated every minute. Demand Integration Times can be set to Off, 5, 8, 15, 20, 30 or 60 minutes. Maximum Demand is the maximum power or current demand that has occurred since the unit was last reset. This is maintained as a continuous record of the highest demand value that has been reached. Note: During the initial period when the “sliding window” does not yet contain a full set of readings (i.e. the elapsed time since the demands were last reset or the elapsed time since the Integra Ci3 digital meter was switched on is less than the selected demand integration time) then maximum demands may not be true due to the absence of immediate historical data.

With the Demand Integration Time set to “Off” the “Maximum Demand” values become “Maximum” values as no averaging is performed on the measured parameters.

8.6 Total Harmonic Distortion

The calculation used for Total Harmonic Distortion is:

$$\text{THD} = ((\text{RMS of total waveform} - \text{RMS of fundamental}) / \text{RMS of total waveform}) \times 100$$

This is often referred to as THD – R, and lies in the range 0 to 100%. THD measurement is subject to the 'range of use' limits. The Integra Ci3 digital meter may give erratic or incorrect readings where the THD is very high and the fundamental is essentially absent. For low signal levels the noise contributions from the signal may represent a significant portion of the “RMS of total waveform” and may thus generate unexpectedly high values of THD. To avoid indicating large figures of THD for low signal levels the product will produce a display of 0 (zero). Typically, display of THD will only produce the 0 (zero) value when the THD calculation has been suppressed due to a low signal level being detected. It should also be noted that spurious signals (for example, switching spikes) may be included in the “RMS of the total waveform” and will be used in the calculation of THD. The display of THD may be seen to fluctuate under these conditions.

9 Glossary

Active energy	Accumulated energy (Watt hours).
CT	Current Transformer. Transforms a (usually) high current to a value that can be monitored by the meter.
Firmware	Software installed on a permanent medium.
Johnson Controls (JC) N2	A master - slave serial communication protocol with fixed communication parameters.
Modbus™	A proprietary communications protocol used for control and monitoring.
Reactive energy	The energy (VARh) in the reactive component of the supply. The current and voltage in the reactive component are mutually 90° out of phase - capacitive or inductive – resulting in a supply power factor of zero.
RS485	A serial communication system linking multiple addressed terminals.
SCADA	Supervisory Control And Data Acquisition system.

10 Index

Address, 21, 31
Auxiliary supply, 31, 35
Baud rate, 18, 31
Certification, 32
Connection Diagrams, 37
Connections, 35
CT, 5, 14
CT earth, 36
CT primary current, 5, 14
Current transformer, 5, 14, 36
Demand Integration Time, 15
Displayed units, 26
dIT, 15
Divisors, 24
Earth connection, 36
EMC, 32, 33
Error, 30
Firmware version, 7, 29
Fuses, 36
Inputs, 30
JC N2, 6, 17
Johnson Controls, 6, 17
LCD check, 27
Maintenance, 33
Meter current, 14
Modbus™, 6, 17, 31, 37
Multiplier, 26
Number entry, 10
Option modules, 31
Parity, 19, 31
Password, 13
Phase sequence, 27
Pulse duration, 25
Pulse output, 6, 8, 22, 31
Pulse rate, 22, 24
Pulse width, 22, 25, 31
Range maximum, 30
Relay output 1, 23
Relay output 2, 23
Reset demand, 16
Reset energy, 16
RoHS, 32
RS485, 6, 31, 37
RS485 address, 21
Safety, 33
Screen check, 7
SET indicator, 10
Size, 32, 34
Standards, 32
Start Up Screens, 7
Stop bits, 20, 31
Supply selection, 14
Temperature, 32, 33
Test, 7, 27
Units, 26
Version, 29
Wiring, 35

While TE Connectivity (TE) has made every reasonable effort to ensure the accuracy of the information in this catalogue, TE does not guarantee that it is error-free, nor does TE make any other representation, warranty or guarantee that the information is accurate, correct, reliable or current. TE reserves the right to make any adjustments to the information contained herein at any time without notice. TE expressly disclaims all implied warranties regarding the information contained herein, including, but not limited to, any implied warranties of merchantability or fitness for a particular purpose. The dimensions in this catalogue are for reference purposes only and are subject to change without notice. Specifications are subject to change without notice. Consult TE for the latest dimensions and design specifications. TE Connectivity and TE connectivity (logo) are trademarks. CROMPTON is a trademark of Crompton Parkinson Limited and is used under licence. Other trademarks are property of their respective owners.

TE Energy – innovative and economical solutions for the electrical power industry: cable accessories, connectors & fittings, insulators & insulation, surge arresters, switching equipment, street lighting, power measurement and control.

Tyco Electronics UK Ltd
A TE Connectivity company
Freebournes Road, Witham
Essex CM8 3AH, UK

Tel: +44 (0) 1376 509509
Fax: +44 (0) 1376 509511
e-mail: Crompton.info@te.com
www.crompton-instruments.com