



# CROMPTON INSTRUMENTS ANALOGUE METERS FOR MARINE APPLICATIONS

# ANALOGUE INSTRUMENTS FOR MARINE APPLICATIONS

High quality analogue instruments designed to measure a wide range of electrical parameters. This comprehensive range offers quadratic instruments in different dimensions. Products are available as voltmeters, ammeters, voltmeters and ammeters incorporating a selector switch, power meters, energy meters incorporating a power indicator, process indicators and synchronoscopes. To suit the needs of the shipbuilding and associated industries, manufacturing equipment for sea-going vessels, these instruments are CE marked and approved by Bureau Veritas (BV) under certification numbers 38933/AO BV, 38940/AO BV, 38941/AO BV, 38942/AO BV.



## Features

- Extensive range
- Accurate measurement and display of electrical parameters
- Up to four different case sizes
- Wide range of specifications
- Designed for reliable operation in marine and offshore environments

## Benefits

- Cost effective
- Local indication
- Easy installation
- Minimal operator training
- Low maintenance level

## Applications

- Switchgear
- Distribution systems
- Control panels
- Process control
- Motor control

## Approval

- Bureau Veritas

## Standards

- CE marked
- BV approved

# CONTENTS

---

<b>AC Voltmeters .....</b>	<b>2</b>
Moving iron AC voltmeters - available in four case sizes . Versions to reflect typical voltage transducer ratios in marine applications complete the range.	
<b>AC Ammeters .....</b>	<b>2</b>
Moving iron AC ammeters for direct AC currents or CT connections. Available in four case sizes with different inputs and scalings for no overload and 2 x or 6 x overload.	
<b>AC Voltmeters and Ammeters Rectified.....</b>	<b>3</b>
Rectified moving coil meters with shielded movement for linear AC measurement. Available in three case sizes for a wide range of inputs.	
<b>DC Voltmeters and Ammeters.....</b>	<b>4</b>
Used for direct measurement of DC signals. Available in four case sizes. Variations allow transducer and shunt indicators. Live zero, offset zero and center zero measurement.	
<b>AC Voltmeters and Ammeters with a Selector Switch.....</b>	<b>5</b>
Integrated selector switch reduces installation time and links the meter clearly to the switch. Ammeter is CT connected. Voltmeters are either direct or VT connected.	
<b>Frequency Meters .....</b>	<b>6</b>
Pointer indicator and reed indicator versions available for a variation of frequency ranges and different voltage levels.	
<b>Phase Sequence Indicator.....</b>	<b>6</b>
Phase sequence indicators are used to determine the correct phase sequence in three phase networks Supplied with two built in glow bulbs indicating correct / incorrect sequence.	
<b>Dual Voltmeters and Dual Frequency Meters .....</b>	<b>7</b>
Used for direct comparison of two electrical systems (bus and generator). Supports to determine the preconditions prior to parallel operation. Frequency meters available as pointer or reed versions.	
<b>Power Factor Meters.....</b>	<b>8</b>
Power factor meters determine if systems are running with inductive or capacitive load. Variation of system connections available. Including “through hole” CT connection.	
<b>Meters for Active or Reactive Power.....</b>	<b>9</b>
Available for different system connections, CT and voltage inputs, these meters come with a “through hole” CT connection and are available for VT calibrations as well.	
<b>Energy Meters with Power Indicator .....</b>	<b>12</b>
Panel mounted energy meters combine a Watt- or Varmeter with a counter for Watthours or Varhours. Available for different electrical systems and voltage levels. Relay output built in as standard.	
<b>Synchroscope and Synchroscope with Syncro-check Relay.....</b>	<b>15</b>
Synchrosopes are used to prevent an asynchronous connection of bus and generator. Available as 360° LED indicators with different functionality. Version with additional LCD display available to show electrical values.	
<b>Technical Details .....</b>	<b>17</b>
<b>Standards and Approvals.....</b>	<b>19</b>

---

# MOVING IRON AMMETERS AND VOLTMETERS

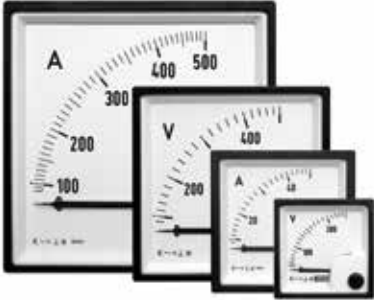

### Features

- Measures AC current or voltage
- Direct or CT connected ammeters
- Direct or VT connected voltmeters
- Moving iron movement
- RMS measurement
- Scaled down to 15%
- Ammeters available with x2 or x6 overload scale

### Benefits

- Easy to operate
- Exchangeable dial
- Terminal cover included

### Applications

- AC switchgears, panels and distribution boards
- Motor current supervision

### Construction

- Sprung pivot bearing type with silicon oil damping
- Slot in screw fixing

### Standards

- CE marked
- BV approved

### Order data/examples

#### Ammeter

- 1) Select type: M243-02A-S,
- 2) Specify input: 0-5A,
- 3) Specify scaling: 0-100A,
- 4) Specify frequency: 50/60Hz

### General Specification

- Accuracy class - 1.5
- Maximum continuous overload -  $1.2 \times I_n$ ,  $1.2 \times U_n$
- Maximum short duration overload -  $10 \times I_n - 9 \times 0.5s + 1 \times 5s / 60s$  -  $2 \times U_n - 9 \times 0.5s + 1 \times 5s / 60s$
- Ammeter burden - 0.3 ... 1.2 VA
- Voltmeter burden - 1.5 ... 4 VA
- Frequency - 50/60 Hz

### Product Codes

Bezel size (mm)	48	72	96	144
Scale length (mm)	41	62	92	135
AC ammeter	M242-02A-S	M243-02A-S	M244-02A-S	M246-02A-S
X2 AC ammeter	M242-022A-S	M243-022A-S	M244-022A-S	M246-022A-S
X6 AC ammeter	M242-026A-S	M243-026A-S	M244-026A-S	M246-026A-S
AC voltmeter	M242-02V-S	M243-02V-S	M244-02V-S	M246-02V-S
<b>Standard input ranges</b>				
AC ammeter (0/x A)	1, 2, 2.5, 4, 5, 6, 10, 15, 20, 25, 30, 40, 60 A (M242 limited to 25A)			
X2 AC ammeter (0/x A)	1/2, 2/4, 2.5/5, 4/8, 5/10, 60/12, 10/20, 15/30, 20/40, 30/60, 40/80, 60/120 A (M242 limited to 25/50A)			
X6 AC ammeter (0/x A)	1/6, 2/12, 2.5/15, 4/24, 5/30, 6/36, 10/60, 15/90, 20/120, 25/150, 30/180, 40/240, 50/300, 60/360 A (M242 limited to 25/150 A)			
AC voltmeter (0/x V)	250V, 300V, 500V, 600V			
AC voltmeter for VT connection (0/x V)	120V (for use with VT's x/100V), 132V (for use with VT's x/110V), 144V (for use with VT's 120V), 125V, 137.5V, 150V (for use with some VT's having primary voltage less than 1kV)			

### Connection Diagrams

#### AC Ammeter

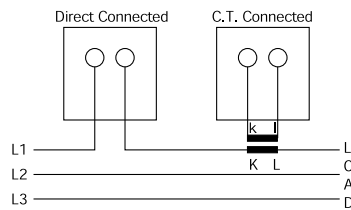

#### AC Voltmeter

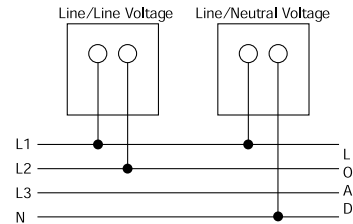

#### Voltmeter

- 1) Select type: M244-02V-S,
- 2) Specify input: 0-500V,
- 3) Specify scaling: 0-500V,
- 4) Specify frequency: 50/60Hz

#### Voltmeter, VT connected

- 1) Select type: M244-02V-S,
- 2) Specify input: 0-120V,
- 3) Specify scaling: 0-12kV,
- 4) Specify frequency: 50/60Hz,
- 5) Specify VT ratio: 10/0.1 kV

# AC AMMETERS AND VOLTMETERS RECTIFIED

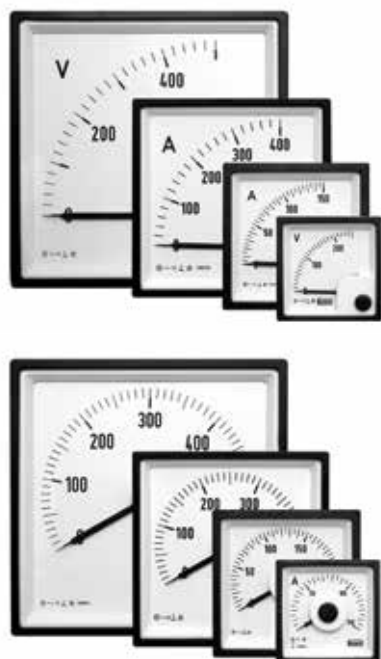

## Features

- Measures AC current or voltage
- CT connected ammeters
- Direct and VT connected voltmeters
- Moving iron movement
- Linear scaling
- 90° short scale and 240° long scale version

## Benefits

- Easy to operate
- Exchangeable dial
- Low consumption
- Terminal cover included

## Applications

- AC switchgears, panels and distribution boards

## Construction

- Mean value measurement of current or voltage
- Containing germanium diodes of low reverse current
- Slot in screw fixing

## Standards

- CE marked
- BV approved

## General Specification

- Accuracy class - 1.5
- Maximum continuous overload -  $1.2 \times I_n$ ,  $1.2 \times U_n$
- Maximum short duration overload -  $10 \times I_n - 9 \times 0.5s + 1 \times 5s / 60s - 2 \times U_n - 9 \times 0.5s + 1 \times 5s / 60s$
- Frequency - 50/60 Hz

## Product Codes

Bezel size (mm)	48	72	96	144
Scale length (mm)	41	62	92	135
AC ammeter rectified 90°	M242-01B-S	M243-01B-S	M244-01B-S	M246-01B-S
AC voltmeter rectified 90°	M242-01W-S	M243-01W-S	M244-01W-S	M246-01W-S
Bezel size (mm)	48	72	96	144
Scale length (mm)	71	113	155	235
AC ammeter rectified 240°	M242-05B-S	M243-05B-S	M244-05B-S	M246-05B-S
AC voltmeter rectified 240°	M242-05W-S	M243-05W-S	M244-05W-S	M246-05W-S
<b>Standard input ranges</b>				
AC a AC ammeter rectified 90° and 240° scaling (O/x A) meter (O/x A)	1, 5 A (M242-05B-S delivered with separated current transformer)			
AC voltmeter rectified 90° and 240° scaling (O/x V)	20, 15, 20, 30, 60, 100, 150, 250, 300 (limit at M242). 400, 500, 600 V			
AC voltmeter for VT connection (O/x V)	120V (for use with VT's x/100V), 132V (for use with VT's x/110V), 144V (for use with VT's 120V), 125V, 137.5V, 150V (for use with some VT's having primary voltage less than 1kV)			

## Connection Diagrams

### AC Ammeter

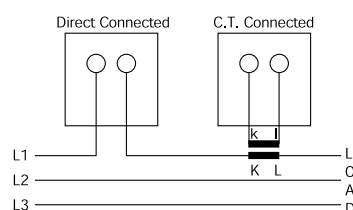

### AC Voltmeter

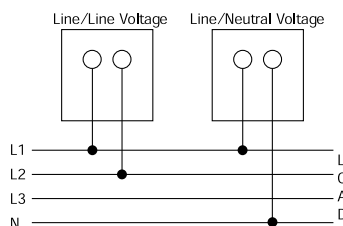

## Order data/examples

### Ammeter

- 1) Select type: M243-01B-S,
- 2) Specify input: 0-1A,
- 3) Specify scaling: 0-1kA,
- 4) Specify frequency: 50/60Hz

### Voltmeter

- 1) Select type: M244-05W-S,
- 2) Specify input: 0-500V,
- 3) Specify scaling: 0-500V,
- 4) Specify frequency: 50/60Hz

### Voltmeter, VT connected

- 1) Select type: M244-05W-S,
- 2) Specify input: 0-120V,
- 3) Specify scaling: 0-12kV,
- 4) Specify frequency: 50/60Hz,
- 5) Specify VT ratio: 10/0.1 kV

## DC AMMETERS AND VOLTMETERS

---



### General Specification

- Accuracy class - 1.5
- Maximum continuous overload -  $1.2 \times I_n$ ,  $1.2 \times U_n$
- Maximum short duration overload -  
 $10 \times I_n - 9 \times 0.5s + 1 \times 5s/60s$   
 $2 \times U_n - 9 \times 0.5s + 1 \times 5s/60s$

### Features

- Measures DC current or voltage
- Direct and shunt connected ammeters
- Direct connected voltmeters
- Live zero ammeters and voltmeters
- Centre zero ammeters and voltmeters
- Moving coil movement
- Linear scaling
- 90° short scale and 240° long scale version

### Benefits

- Easy to operate
- Exchangeable dial
- Terminal cover included

### Applications

- DC switchgears, panels and distribution boards
- Control boards
- Process indication
- Battery supervision

### Construction

- Magnet core none sensitive to external fields
- Slot in screw fixing

### Standards

- CE marked
- BV approved

## Product Codes

Bezel size (mm)	48	72	96	144
Scale length (mm)	41	62	92	135
DC ammeter 90°	M242-01A-S	M243-01A-S	M244-01A-S	M246-01A-S
DC voltmeter 90°	M242-01V-S	M243-01V-S	M244-01V-S	M246-01V-S
DC ammeter 90° live zero	M242-01R-S	M243-01R-S	M244-01R-S	M246-01R-S
DC voltmeter 90° live zero	M242-01S-S	M243-01S-S	M244-01S-S	M246-01S-S
DC ammeter 90° centre zero	M242-01C-S	M243-01C-S	M244-01C-S	M246-01C-S
DC voltmeter 90° centre zero	M242-01N-S	M243-01N-S	M244-01N-S	M246-01N-S
Bezel size (mm)	48	72	96	144
Scale length (mm)	71	113	155	235
DC ammeter 240°	M242-05A-S	M243-05A-S	M244-05A-S	M246-05A-S
DC voltmeter 240°	M242-05V-S	M243-05V-S	M244-05V-S	M246-05V-S
DC ammeter 240° live zero	M242-05R-S	M243-05R-S	M244-05R-S	M246-05R-S
DC voltmeter 240° live zero	M242-05S-S	M243-05S-S	M244-05S-S	M246-05S-S
DC ammeter 240° centre zero	M242-05C-S	M243-05C-S	M244-05C-S	M246-05C-S
DC voltmeter 240° centre zero	M242-05N-S	M243-05N-S	M244-05N-S	M246-05N-S
<b>Standard input ranges</b>				
DC ammeter 90° and 240° scaling (0/x A)	1, 1.5, 2.5, 4, 5, 6, 10, 15, 20, 25 (limit on M242), 30, 40, 50, 60 A			
DC ammeter 90° and 240° scaling, process and shunt indicators	0-1, 0-5, 0-10, 0-20, 4-20 mA, 0-50, 0-60, 0-75 mV			
DC ammeter 90° and 240° scaling, centre zero (x-0-x A)	1-0-1, 1.5-0-1.5, 2.5-0-2.5, 4-0-4, 5-0-5, 6-0-6, 10-0-10 (limit on M242), 15-0-15, 20-0-20, 25-0-25, 30-0-30 A			
DC ammeter 90° and 240° scaling, centre zero process and shunt indicators	1-0-1, 5-0-5, 10-0-10, 20-0-20 mA, 50-0-50, 60-0-60, 75-0-75 mV			
DC voltmeter 90° and 240° scaling (0/x V)	10, 15, 20, 30, 60, 100, 150, 250, 300 (limit on M242), 400, 500, 600 V			
DC voltmeter 90° and 240° scaling, process indicators	1-5, 2-10 V			
DC voltmeter 90° and 240° scaling, centre zero (x-0-x V)	10-0-10, 15-0-15, 20-0-20, 30-0-30, 60-0-60, 100-0-100, 150-0-150 (limit on M242), 250-0-250, 300-0-300 V			

## Connection Diagrams

### DC Voltmeter

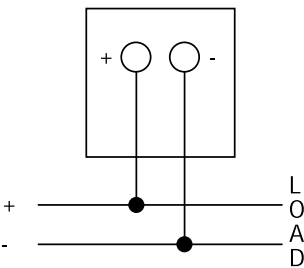

### DC Ammeter

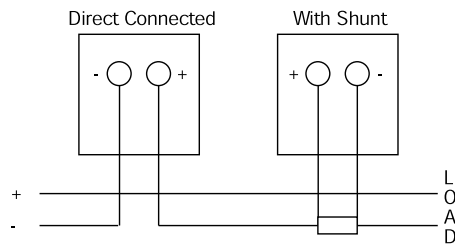

### Transducer Indicator

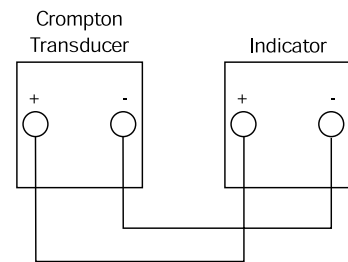

## Order data/examples

### Ammeter

#### Example A

- 1) Select type: M243-01A-S,
- 2) Specify input: 0-10 A,
- 3) Specify scaling: 0-10 A

#### Example B

- 1) Select type: M244-05R-S,
- 2) Specify input: 4-20 mA,
- 3) Specify scaling: 0-100 MVA

#### Example C

- 1) Select type: M244-01C-S,
- 2) Specify input: 60-0-60 mV,
- 3) Specify scaling: 150-0-150 A

### Voltmeter

#### Example A

- 1) Select type: M244-01V-S,
- 2) Specify input: 0-15 V,
- 3) Specify scaling: 0-15 V

#### Example B

- 1) Select type: M244-05S-S,
- 2) Specify input: 2-10 V,
- 3) Specify scaling: 0-100 %

#### Example C

- 1) Select type: M242-01N-S,
- 2) Specify input: 10-0-10 V,
- 3) Specify scaling: 20-0-20 A

# AC AMMETERS AND VOLTMETER WITH SELECTOR SWITCH

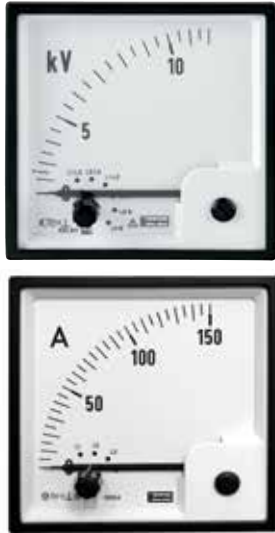

## Features

- Measures AC current or voltage
- CT connected ammeters
- Direct and VT connected voltmeters
- Voltmeter available in 72mm x 72mm and 96mm x 96 mm
- Ammeter with moving coil rectified movement
- Voltmeter with moving iron movement

## Benefits

- Easy to operate
- Exchangeable dial
- Terminal cover included
- Space saving
- Clear link between switch and meter

## Applications

- AC switchgears, panels and distribution boards
- Control boards

## Construction

- Ammeter measures mean value of rectified current
- Voltmeter measures true RMS value independent from waveform
- Slot in screw fixing

## Standards

- CE marked
- BV approved

## General Specification

- Accuracy class - 1.5
- Maximum continuous overload -  $1.2 \times I_n$ ,  $1.2 \times U_n$
- Maximum short duration overload -  $10 \times I_n - 9 \times 0.5s + 1 \times 5s/60s - 2 \times U_n - 9 \times 0.5s + 1 \times 5s/60s$
- Voltage drop ammeter -  $x/5A$  approx. 0.03 V,  $x/1A$  approx. 0.1 V
- Burden voltmeter - 1.5 ... 4 VA
- Voltmeter switch - L1-L2/L2-L3/L1-L3/L1-N/L2-N/L3-N
- Ammeter switch - L1/L2/L3/OFF

## Product Codes

Bezel size (mm)	-	72	96	-
Scale length (mm)	-	63	92	-
AC ammeter with switch	-	-	M244-02E-S	-
AC voltmeter with switch	-	M243-02Q-S	M244-02Q-S	-
Standard input ranges				
AC ammeter with switch (0/x A)	1, 5 A			
AC voltmeter with switch (0/x V)	250V, 300V, 500V, 600V			
AC voltmeter for VT connection (0/x V)	120V (for use with VT's $x/100V$ ), 132V (for use with VT's $x/110V$ ), 144V (for use with VT's 120V), 125V, 137.5V, 150V (for use with some VT's having primary voltage less than 1kV)			
Frequency	50/60 Hz			

## Connection Diagrams

### Voltmeter with switch

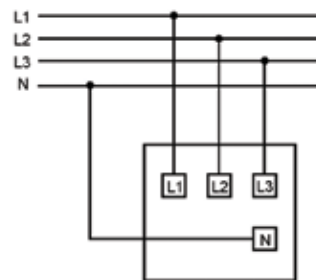

### Ammeter with switch

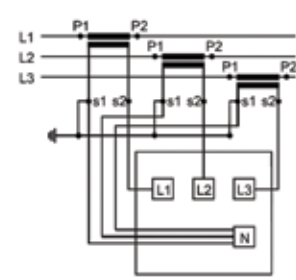

## Order data/examples

### Ammeter with switch

- 1) Select type: M244-02E-S,
- 2) Specify input: 0-5A,
- 3) Specify scaling: 0-100A,
- 4) Specify frequency: 50/60Hz

### Voltmeter

- 1) Select type: M244-02Q-S,
- 2) Specify input: 0-500V,
- 3) Specify scaling: 0-500V,
- 4) Specify frequency: 50/60Hz

### Voltmeter, VT connected

- 1) Select type: M244-02Q-S,
- 2) Specify input: 0-120V,
- 3) Specify scaling: 0-12kV,
- 4) Specify frequency: 50/60Hz,
- 5) Specify VT ratio: 10/0.1 kV



# FREQUENCY METERS WITH POINTER OR REEDS



## Features

- Measures AC Frequencies
- Pointer type available as 90° short scale and 240° long scale version
- Reed type available with
  - 13 reeds (47-53 Hz, 57-63 Hz)
  - 21 reeds (45-55 Hz, 55-65 Hz)
- Direct or VT connected

## Benefits

- Easy to operate
- High visibility
- Terminal cover included

## Applications

- AC switchgears, panels and distribution boards
- Control board
- Generator sets

## Construction

- Pointer type contains internal transducer, powered from input voltage and moving coil meter
- Reed type uses steel reeds in an electromagnetic field. Reeds are calibrated to its individual frequency to vibrate in resonance with the electromagnet and vibrates at full amplitude

## Standards

- CE marked
- BV approved

## General Specification

- Accuracy class - 0.5 - 1.2 x Un continuously
- Overload - 1.5 x Un for 2 hours (pointer type only) - 2 x Un for 5 seconds - 1 VA at nominal voltage 57-110 V and 230 V
- Burden pointer type - 1.7 VA at nominal voltage 400V - 2VA at nominal voltage 500V
- Burden reed type - 0.7 ... 1.2 VA at nominal voltage 110-230 V - 1.4 ... 2 VA at all other nominal voltages

## Product Codes

Bezel size (mm)	96	96	96	96
Scale length (mm)	95	135	-	-
Frequency meter 90°	M244-41S-S	-	-	-
Frequency meter 240°	-	M244-41L-S	-	-
Frequency meter 13 reeds	-	-	M244-41R-S	-
Frequency meter 21 reeds	-	-	-	M244-41R-S
<b>Standard input ranges</b>				
Pointer type	57-110 V, 400V +/- 20%, 500V +/-20%			
Reed type	100V, 110V, 230V, 400V +/- 20%, 500V +/-20%			
<b>Scaling</b>				
13 reeds on reed type meters with scaling:	47-50-53 Hz, 57-60-63 Hz			
21 reeds on reed type meters with scaling:	45-50-55 Hz, 55-60-65 Hz			
Scaling on 90° and 240° pointer types	45-50-55 Hz, 55-60-55 Hz, 45-55-65 Hz			

## Connection Diagrams

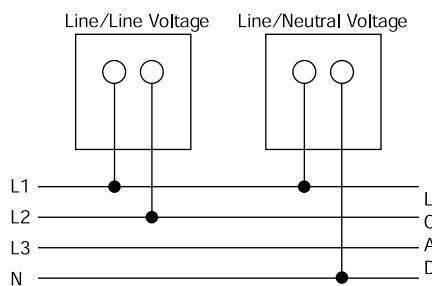

## Order data/examples

### Pointer type 90°

- 1) Select type: M244-41S-S,
- 2) Specify input voltage: 400V,
- 3) Specify frequency 45/55 Hz,
- 4) Specify scaling: 45-50-55 Hz

### Pointer type 240°

- 1) Select type: M244-41L-S,
- 2) Specify input voltage: 57-110V,
- 3) Specify frequency 45/65 Hz,
- 4) Specify scaling: 45-55-65 Hz

### Reed type 13 reeds

- 1) Select type: M244-41R-S,
- 2) Specify input voltage: 230V,
- 3) Specify frequency 47/53 Hz,
- 4) Specify scaling: 47-50-53 Hz

### Reed type 21 reeds

- 1) Select type: M244-41R-S,
- 2) Specify input voltage: 110V,
- 3) Specify frequency 55/65 Hz,
- 4) Specify scaling: 55-60-65 Hz

# PHASE SEQUENCE INDICATOR



## Features

- Determines phase sequence in a 3-phase network
- Glow bulbs indicate L1, L2, L3 phase sequence

## Benefits

- Easy to operate
- Terminal cover included

## Applications

- AC switchgears, panels and distribution boards
- Control board
- Generator sets

## Standards

- CE marked
- BV approved

## General Specification

- Standard input ranges - 200-500 V, 50/60 Hz

## Product Codes

Bezel size (mm)	96	-	-	-
Scale length (mm)	-	-	-	-
Phase sequence indicator	M244-12P-S	-	-	-

## Order data/examples

### Phase sequence indicator

- 1) Select type: M244-12P-S,
- 2) Specify input voltage: 200-500V,
- 3) Specify frequency 50 or 60 Hz

## Connection Diagrams

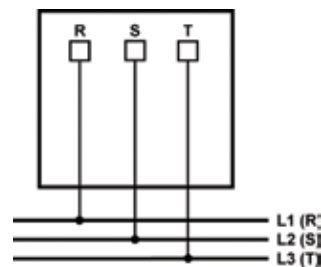

# DUAL VOLTMETER AND FREQUENCY METER



### Features

- Measures AC frequencies of two independent systems
- Pointer type dual voltmeter and frequency meter with two independent 90° short scale movements
- Reed type available with two independent measuring circuits - 21 reeds (45-55 Hz, 55-65 Hz)
- Direct or VT connected

### Benefits

- Easy to operate
- High visibility
- Terminal cover included

### Applications

- AC switchgears, panels and distribution boards
- Control board
- Generator sets

### Construction

- Pointer type contains internal transducer, powered from input voltage and moving coil meter
- Reed type uses steel reeds in an electromagnetic field. Reeds are calibrated to its individual frequency to vibrate in resonance with the electromagnet and vibrates at full amplitude
- Slot in screw fixing

### Standards

- CE marked
- BV approved

### General Specification

- Accuracy class dual voltmeter - 1.5
- Accuracy class dual frequency meter - pointer type - 1
- Accuracy class dual frequency meter - reed type - 0.5
- Overload - 10xIn - 9x0.5s+1x5s/60s
- Dual voltmeter - 2xUn - 9x0.5s+1x5s/60s
- Dual frequency meter - pointer type - 1.2 x Un continuously, 1.5 x Un for 2 hours (pointer type only)
- Dual frequency meter - reed type - 2 x Un for 5 seconds
- Burden frequency meter - pointer type - 1 VA at nominal voltage 57-110 V and 230 V - 1.7 VA at nominal voltage 400V - 2VA at nominal voltage 500V
- Burden frequency meter - reed type - 0.7 ... 1.2 VA at nominal voltage 110-230 V - 1.4 ... 2 VA at all other nominal voltages

### Product Codes

Bezel size (mm)	96	96	96	-
Scale length (mm)	41	41	-	-
Voltmeter meter 2 x 90°	M244-80L-S	-	-	-
Frequency meter 2 x 90°	-	M244-41D-S	-	-
Frequency meter 2 x 21 reeds	-	-	M244-41E-S	-
<b>Standard input ranges</b>				
Dual voltmeter (direct connected)	300V, 500V			
Dual voltmeter (VT connected)	120V (for use with VT's x/100V), 132V (for use with VT's x/110V), 144V (for use with VT's 120V), 125V, 137.5V, 150V (for use with some VT's having primary voltage less than 1kV)			
Dual frequency meter - pointer type	57-110 V, 400V +/- 20%, 500V +/-20%			
Dual frequency meter - reed type	100V, 110V, 230V, 400V +/- 20%, 500V +/-20%			
<b>Scaling</b>				
Dual voltmeter	Specify to suit application			
Dual frequency meter - pointer type	45-50-55 Hz, 55-60-55 Hz, 45-55-65 Hz			
Dual frequency meter - reed type	45-50-55 Hz, 55-60-65 Hz			

### Connection Diagrams

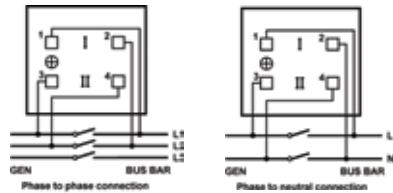

### Order data/examples

#### Dual voltmeter - LV direct connected

- 1) Select type: M244-80L-S,
- 2) Specify input voltage: 500V,
- 3) Specify scaling: 0-500V,
- 4) Specify frequency: 50 Hz

#### Dual voltmeter - VT connected

- 1) Select type: M244-80L-S,
- 2) Specify input: 0-120V,
- 3) Specify scaling: 0-12kV,
- 4) Specify frequency: 50Hz,
- 5) Specify VT ratio: 10/0.1 kV

#### Dual frequency meter - pointer type

- 1) Select type: M244-41D-S,
- 2) Specify input voltage: 400V,
- 3) Specify frequency 45/65 Hz,
- 4) Specify scaling: 45-55-65 Hz

#### Dual frequency meter - reed type

- 1) Select type: M244-41E-S,
- 2) Specify input voltage: 110V,
- 3) Specify frequency 55/65 Hz,
- 4) Specify scaling: 55-60-65 Hz

# POWER FACTOR METERS

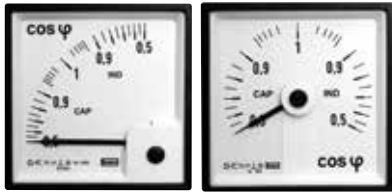

### Features

- Indicates Power factor of electrical systems
- Several voltage ranges available
- Current connection via “through hole” CT on the instrument. No need to interrupt wiring from CT

### Benefits

- Easy to operate
- High visibility
- Terminal cover included
- Low self consumption
- Internal power supply from voltage input

### Applications

- AC switchgears, panels and distribution boards
- Control boards
- Generator sets

### Construction

- Instruments operate on a fast sampling method of input quantities (current and voltage) of the connected phases
- Meters include “through hole” CT connection, voltage dividers, internal microprocessor and power supply unit
- Slot in screw fixing

### Standards

- CE marked
- BV approved

### Order data/examples

#### Single-phase

- 1) Select type: M244-420-S,
- 2) Specify input voltage and current: 230V L-N/5A,
- 3) Specify scaling: 0.5/1/0.5 CAP/IND
- 4) Specify frequency: 50/60 Hz,

#### 3-phase 4-wire balanced

- 1) Select type: M244-13D-S,
- 2) Specify input voltage and current: 69.3V L-N/1A,
- 3) Specify scaling: 0.5/1/0.5 CAP/IND,
- 4) Specify frequency: 50/60 Hz

### General Specification

- Accuracy class - 1.5
- Maximum continuous overload - 3 x In, 1.5 x Un
- Maximum short duration overload - 25 x In for 30 seconds, 50 x In for 1 second, 2 x Un for 10 seconds
- Voltage burden - <0.1VA per phase
- Current burden - <0.1VA per phase
- Frequency - 50/60 Hz

### Product Codes

Bezel size (mm)	96	96	96	96	96
Scale length (mm)	95	95	95	95	95
Power factor meter 90°	M244-420-S Single-phase	M244-421-S 3P/3W balanced	M244-42C-S 3P/4W balanced	M244-423-S 3P/3W unbalanced	M244-424-S 3P/4W unbalanced
Bezel size (mm)	96	96	96	96	96
Scale Length (mm)	135	135	135	135	135
Power factor meter 240°	M244-135-S Single-phase	M244-136-S 3P/3W balanced	M244-13D-S 3P/4W balanced	M244-138-S 3P/3W unbalanced	M244-139-S 3P/4W unbalanced
<b>Standard input ranges</b>					
Single-phase, 3P/4W balanced, 3P/4W unbalanced	57.7V L-N/1A, 57.7V L-N/5A, 63.5V L-N/1A, 63.5V L-N/5A, 69.3V L-N/1A, 9.3V L-N/5A, 230V L-N/1A, 230V L-N/5A, 240V L-N/1A, 240V L-N/5A, 254V L-N/1A, 254V L-N/5A,				
3P/3W balanced, 3P/3W unbalanced	100V L-L/1A, 100V L-L/5A, 110V L-L/1A, 110V L-L/5A, 400V L-L/1A, 400V L-L/5A, 415V L-L/1A, 415V L-L/5A, 440V L-L/1A, 440V L-L/5A				
Scaling	0.5/1/0.5 CAP/IND or 0.8/1/0.2 CAP/IND				

### Connection Diagrams

#### Single-phase

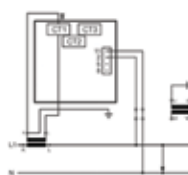

#### 3-phase 3-wire (3P/3W) balanced

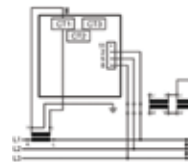

#### 3-phase 4-wire (3P/4W) balanced

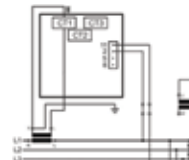

#### 3-phase 3-wire (3P/4W) unbalanced

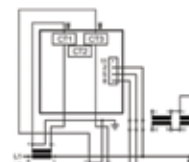

#### 3-phase 4-wire (3P/4W) unbalanced

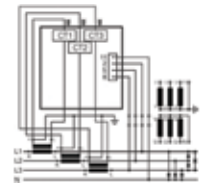

#### 3-phase 4-wire unbalanced

- 1) Select type: M244-424-S,
- 2) Specify input voltage and current: 230V L-N/5A,
- 3) Specify scaling: 0.8/1/0.2 CAP/IND
- 4) Specify frequency: 50/60 Hz

#### 3-phase 3-wire balanced

- 1) Select type: M244-136-S,
- 2) Specify input voltage and current: 110V L-L/5A,
- 3) Specify scaling: 0.5/1/0.5 CAP/IND,
- 4) Specify frequency: 50/60 Hz

#### 3-phase 3-wire unbalanced

- 1) Select type: M244-138-S,
- 2) Specify input voltage and current: 415V L-L/1A,
- 3) Specify scaling: 0.5/1/0.5 CAP/IND,
- 4) Specify frequency: 50/60 Hz

# WATTMETERS



## Features

- Indicates active power of electrical systems
- Several voltage ranges available
- Current connection via “through hole” CT on the instrument. No need to interrupt wiring from CT.

## Benefits

- Easy to operate
- High visibility
- Terminal cover included
- Low self consumption
- Internal power supply from voltage input

## Applications

- AC switchgears, panels and distribution boards
- Control boards
- Generator sets

## Construction

- Instruments operate on a fast sampling method of input quantities (current and voltage) of the connected phases.
- Meters include “through hole” CT connection, voltage dividers, internal microprocessor and power supply unit.
- Slot in screw fixing

## Standards

- CE marked
- BV approved

## Order data/examples

### Single-phase

- 1) Select type: M244-210-S,
- 2) Specify input voltage and CT ratio: 230V L-N, 50/5A,
- 3) Specify scaling: 0-10 kW,
- 4) Specify frequency: 50/60 Hz,

### 3-phase 4-wire balanced or

### 3-phase 4-wire unbalanced

- 1) Select type: M244-21D-S,
- 2) Specify input voltage and CT ratio: 230 V L-N, 400/5A,
- 3) Specify scaling: 0-250 kW,
- 4) Specify frequency: 50/60 Hz

## General Specification

- Accuracy class - 1.5
- Maximum continuous overload -  $3 \times I_n$ ,  $1.5 \times U_n$
- Maximum short duration overload -  $25 \times I_n$  for 30 seconds,  $50 \times I_n$  for 1 second,  $2 \times U_n$  for 10 seconds
- Voltage burden -  $<0.1VA$  per phase • Current burden -  $<0.1VA$  per phase
- Frequency - 50/60 Hz

## Product Codes

Bezel size (mm)	96	96	96	96	96
Scale length (mm)	95	95	95	95	95
Wattmeter 90°	M244-210-S Single-phase	M244-211-S 3P/3W balanced	M244-21C-S 3P/4W balanced	M244-213-S 3P/3W unbalanced	M244-214-S 3P/4W unbalanced
Bezel size (mm)	96	96	96	96	96
Scale Length (mm)	135	135	135	135	135
Wattmeter 240°	M244-215-S Single-phase	M244-216-S 3P/3W balanced	M244-21D-S 3P/4W balanced	M244-218-S 3P/3W unbalanced	M244-219-S 3P/4W unbalanced
<b>Standard input ranges</b>					
Single-phase, 3P/4W balanced, 3P/4W unbalanced	57.7V L-N/1A, 57.7V L-N/5A, 63.5V L-N/1A, 63.5V L-N/5A, 230V L-N/1A, 230V L-N/5A, 240V -N/1A, 240V L-N/5A, 254V L-N/1A, 254V L-N/5A,				
3P/3W balanced, 3P/3W unbalanced	100V L-L/1A, 100V L-L/5A, 110V L-L/1A, 110V L-L/5A, 400V L-L/1A, 400V L-L/5A, 415V L-L/1A, 415V L-L/5A, 440V L-L/1A, 440V L-L/5A				

## Calculation of end scale value

End scale value is calculated using the formula below, where correct voltage must be selected (either L-N or L-L), depending on the electrical system and the type of meter used. Scale factor, e.g. the relation between end scale value and nominal apparent power ( $\cos\phi = 1$ ) must be between 0.6 to 1.2. It is recommended selecting the scale value from 1 - 1.2 - 1.25 - 1.5 - 2 - 2.5 - 3 - 4 - 5 - 6 - 7.5 - 8 (and their decades) closest to the calculated result..

Electrical system	Formula	Example	End scale value to choose (considering 0,6 to 1.2 x S)
Single-phase, direct voltage connection	$P = U(L-N) \times I_p \times \cos \phi$	$P = 230V \times 50A \times 0.9 = 10350 W = 10.35 kW$	10 kW
3-phase 4-wire, direct voltage connection (balanced or unbalanced)	$P = 3 \times U(L-N) \times I_p \times \cos \phi$	$P = 3 \times 230V \times 400A \times 0.95 = 262200 W = 262,2 kW$	250 kW
3-phase 3-wire, direct voltage connection (balanced or unbalanced)	$P = 1.732 \times U(L-L) \times I_p \times \cos \phi$	$P = 1.732 \times 400V \times 1000A \times 0,9 = 623520 W = 623,52 kW$	600 kW
3-phase 4-wire, voltage connection via VT (balanced or unbalanced)	$P = 3 \times U_p(L-N) \times I_p \times \cos \phi$	$P = 3 \times 5770V \times 100A \times 0.95 = 1644450 W = 1,64445 MW$	1.5 MW
3-phase 3-wire, voltage connection via VT (balanced or unbalanced)	$P = 1.732 \times U_p(L-L) \times I_p \times \cos \phi$	$P = 1.732 \times 30000V \times 50A \times 0,9 = 2338200 W = 2,3382 MW$	2,5 MW

### 3-phase 3-wire balanced or unbalanced

- 1) Select type: M244-213-S,
- 2) Specify input voltage and CT ratio: 400V L-L, 1000/1A,
- 3) Specify scaling: 0-600 kW,
- 4) Specify frequency: 50/60 Hz

### 3-phase 4-wire balanced or unbalanced, VT connected

- 1) Select type: M244-214-S,
- 2) Specify VT ratio and CT ratio: 5770/57.7V L-N, 100/5A,
- 3) Specify scaling: 0-1.5 MW,
- 4) Specify frequency: 50/60 Hz

### 3-phase 3-wire balanced or unbalanced

- 1) Select type: M244-218-S,
- 2) Specify input VT ratio and CT ratio: 30000/110V L-L, 50/1A,
- 3) Specify scaling: 0-2.5 MW
- 4) Specify frequency: 50/60 Hz

# VARMETERS



## Features

- Indicates reactive power of electrical systems
- Several voltage ranges available
- Current connection via “through hole” CT on the instrument. No need to interrupt wiring from CT.

## Benefits

- Easy to operate
- High visibility
- Terminal cover included
- Low self consumption
- Internal power supply from voltage input

## Applications

- AC switchgears, panels and distribution boards
- Control boards
- Generator sets

## Construction

- Instruments operate on a fast sampling method of input quantities (current and voltage) of the connected phases.
- Meters include “through hole” CT connection, voltage dividers, internal microprocessor and power supply unit.
- Slot in screw fixing

## Standards

- CE marked
- BV approved

## Order data/examples

### Single-phase

- 1) Select type: M244-310-S,
- 2) Specify input voltage and CT ratio: 230V L-N, 50/5A,
- 3) Specify scaling: 0-6 kvar,
- 4) Specify frequency: 50/60 Hz,

### 3-phase 4-wire balanced or 3-phase 4-wire unbalanced

- 1) Select type: M244-31D-S,
- 2) Specify input voltage and CT ratio: 230 V L-N, 400/5A,
- 3) Specify scaling: 0-200 kvar,
- 4) Specify frequency: 50/60 Hz

## General Specification

- Accuracy class - 1.5
- Maximum continuous overload - 3 x In, 1.5 x Un
- Maximum short duration overload - 25 x In for 30 seconds, 50 x In for 1 second, 2 x Un for 10 seconds
- Voltage burden - <0.1VA per phase • Current burden - <0.1VA per phase
- Frequency - 50/60 Hz

## Product Codes

Bezel size (mm)	96	96	96	96	96
Scale Length (mm)	95	95	95	95	95
Varmeter 90°	M244-310-S Single-phase	M244-311-S 3P/3W balanced	M244-31C-S 3P/4W balanced	M244-313-S 3P/3W unbalanced	M244-314-S 3P/4W unbalanced
Bezel size (mm)	96	96	96	96	96
Scale length (mm)	135	135	135	135	135
Varmeter 240°	M244-315-S Single-phase	M244-316-S 3P/3W balanced	M244-31D-S 3P/4W balanced	M244-318-S 3P/3W unbalanced	M244-319-S 3P/4W unbalanced
<b>Standard input ranges</b>					
Single-phase, 3P/4W balanced, 3P/4W unbalanced	57.7V L-N/1A, 57.7V L-N/5A, 63.5V L-N/1A, 63.5V L-N/5A, 230V L-N/1A, 230V L-N/5A, 240V L-N/1A, 240V L-N/5A, 254V L-N/1A, 254V L-N/5A,				
3P/3W balanced, 3P/3W unbalanced	100V L-L/1A, 100V L-L/5A, 110V L-L/1A, 110V L-L/5A, 400V L-L/1A, 400V L-L/5A, 415V L-L/1A, 415V L-L/5A, 440V L-L/1A, 440V L-L/5A				

## Calculation of end scale value

End scale value is calculated using the formula below, where correct voltage must be selected (either L-N or L-L), depending on the electrical system and the type of meter used. Scale factor, e.g. the relation between end scale value and nominal apparent power (cos-phi = 1) must be between 0.6 to 1.2. It is recommended selecting the scale value from 1 - 1.2 - 1.25 - 1.5 - 2 - 2.5 - 3 - 4 - 5 - 6 - 7.5 - 8 (and their decades) closest to the calculated result..

$I_p$  = CT primary current,  $U_p$  = VT primary voltage,  $U$  = direct connected voltage,  $\sin \phi$  = power factor

Electrical system	Formula	Example	End scale value to choose (considering 0,6 to 1.2 x S)
Single-phase, direct voltage connection	$Q = U(L-N) \times I_p \times \sin \phi$	$Q = 230V \times 50A \times 0,44 = 5060 \text{ var} = 5,06 \text{ kvar}$	6 kvar
3-phase 4-wire, direct voltage connection (balanced or unbalanced)	$Q = 3 \times U(L-N) \times I_p \times \sin \phi$	$P = 3 \times 230V \times 400A \times 0,31 = 85560 \text{ var} = 85,56 \text{ kvar}$	200 kvar
3-phase 3-wire, direct voltage connection (balanced or unbalanced)	$Q = 1,732 \times U(L-L) \times I_p \times \sin \phi$	$P = 1,732 \times 400V \times 1000A \times 0,44 = 304832 \text{ var} = 304,8 \text{ kvar}$	500 kvar
3-phase 4-wire, voltage connection via VT (balanced or unbalanced)	$Q = 3 \times U_p(L-N) \times I_p \times \sin \phi$	$P = 3 \times 5770V \times 100A \times 0,199 = 344469 \text{ var} = 344,469 \text{ kvar}$	1 Mvar
3-phase 3-wire, voltage connection via VT (balanced or unbalanced)	$Q = 1,732 \times U_p(L-L) \times I_p \times \sin \phi$	$P = 1,732 \times 30000V \times 50A \times 0,44 = 1143120 \text{ var} = 1,14312 \text{ Mvar}$	2 Mvar

### 3-phase 3-wire balanced or unbalanced

- 1) Select type: M244-313-S,
- 2) Specify input voltage and CT ratio: 400V L-L, 1000/1A,
- 3) Specify scaling: 0-500 kvar,
- 4) Specify frequency: 50/60 Hz

### 3-phase 4-wire balanced or unbalanced, VT connected

- 1) Select type: M244-314-S,
- 2) Specify VT ratio and CT ratio: 5770/57.7V L-N, 100/5A,
- 3) Specify scaling: 0-1 Mvar,
- 4) Specify frequency: 50/60 Hz

### 3-phase 3-wire balanced or unbalanced

- 1) Select type: M244-318-S,
- 2) Specify input VT ratio and CT ratio: 30000/110V L-L, 50/1A,
- 3) Specify scaling: 0-2 Mvar, 4) specify frequency: 50/60 Hz

# WIRING DIAGRAMS OF WATTMETERS AND VAR METERS



### Single-phase, direct or VT voltage connection

- Wattmeter M244-210-S
- Wattmeter M244-215-S
- Varmeter M244-310-S
- Varmeter M244-315-S

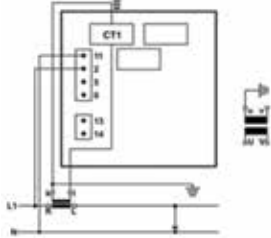

### 3-phase 3-wire balanced, direct or VT voltage connection

- Wattmeter M244-211-S
- Wattmeter M244-216-S
- Varmeter M244-311-S
- Varmeter M244-316-S

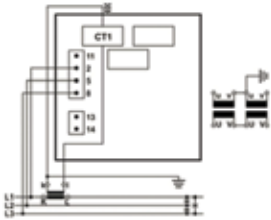

### 3-phase 4-wire balanced, direct or VT voltage

- Wattmeter M244-21C-S
- Wattmeter M244-21D-S
- Varmeter M244-31C-S
- Varmeter M244-31D-S

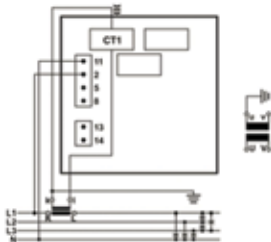

### 3-phase 3-wire unbalanced, direct or VT voltage connection

- Wattmeter M244-213-S
- Wattmeter M244-218-S
- Varmeter M244-313-S
- Varmeter M244-318-S

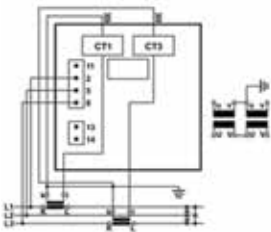

### 3-phase 4-wire unbalanced, direct or VT voltage connection

- Wattmeter M244-214-S
- Wattmeter M244-219-S
- Varmeter M244-314-S
- Varmeter M244-319-S

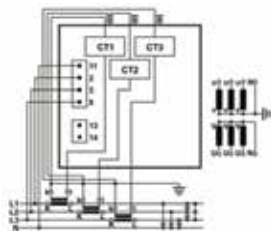

# ACTIVE ENERGY METER WITH POWER INDICATOR



## Features

- Counts electrical active energy and indicates active power of electrical systems
- Several voltage ranges available
- Current connection via “through hole” CT on the instrument. No need to interrupt wiring from CT
- Pulsed output as standard

## Benefits

- High visibility
- Terminal cover included
- Low self consumption
- Separated power supply

## Applications

- AC switchgears, panels and distribution boards
- Control boards
- Generator sets

## Construction

- Instruments operate on a fast sampling method of input quantities (current and voltage) of the connected phases
- Meters include “through hole” CT connection, voltage dividers, internal microprocessor and power supply unit
- Slot in screw fixing

## Standards

- CE marked
- BV approved

## Order data/examples

### Single-phase

- 1) Select type: M244-HWG-S,
- 2) Specify input voltage and CT ratio: 230V L-N, 50/5A,
- 3) Spec. scaling: 0-10 kW,
- 4) Spec. frequency: 50/60 Hz,
- 5) Select pulse rate: 1p/10kWh,
- 6) Select output: 1 pulsed output

### 3-phase 4-wire balanced or 3-phase 4-wire unbalanced

- 1) Select type: M244-HWK-S,
- 2) Specify input voltage and CT ratio: 230 V L-N, 400/5A,
- 3) Spec. scaling: 0-250 kW, 4) spec. frequency: 50/60 Hz,

## General Specification

- Accuracy class active power meter - 1.5
- Accuracy class active energy meter - 1 to EN 62053-21
- Maximum continuous overload - 2 x In, 1.2 x Un
- Nominal frequency - 50/60 Hz
- Voltage burden - <0.1VA per phase
- Current burden - <0.1VA per phase
- Power supply - 20-300 VDC / 48-276 VAC
- Frequency - 40-65 Hz
- Voltage burden - <3 VA
- Pulsed output - 1 SO pulsed output with 1p/10kWh, 1p/100kWh, 1p/10MWh, 1p/100MWh. Maximum pulse rate may not exceed 33 pulses per second (1980 pulses per minute). If in doubt choose next higher value, e.g. 1p/100/kWh instead of 1p/10kWh

## Product Codes

Bezel size (mm)	96	96	96	96	96
Scale length (mm)	95	95	95	95	95
Active energy meter with Wattmeter 90°	M244-HWG-S Single-phase	M244-HWH-S 3P/3W balanced	M244-HWV-S 3P/4W balanced	M244-HWJ-S 3P/3W unbalanced	M244-HWK-S 3P/4W unbalanced
Bezel size (mm)	96	96	96	96	96
Scale Length (mm)	135	135	135	135	135
Active energy meter with Wattmeter 240°	M244-HWB-S Single-phase	M244-HWC-S 3P/3W balanced	M244-HWU-S 3P/4W balanced	M244-HWD-S 3P/3W unbalanced	M244-HWE-S 3P/4W unbalanced
<b>Standard input ranges</b>					
Single-phase, 3P/4W balanced & unbalanced	57.7V L-N/1A, 57.7V L-N/5A, 63.5V L-N/1A, 63.5V L-N/5A, 230V L-N/1A, 230V L-N/5A, 240V L-N/1A, 240V L-N/5A, 254V L-N/1A, 254V L-N/5A,				
3P/3W balanced & unbalanced	1100V L-L/1A, 100V L-L/5A, 110V L-L/1A, 110V L-L/5A, 400V L-L/1A, 400V L-L/5A, 415V L-L/1A, 415V L-L/5A, 440V L-L/1A, 440V L-L/5A				

## Calculation of end scale value

End scale value is calculated using the formula below, where correct voltage must be selected (either L-N or L-L), depending on the electrical system and the type of meter used. Scale factor, e.g. the relation between end scale value and nominal apparent power (cos-phi = 1) must be between 0.6 to 1.2. It is recommended selecting the scale value from 1 - 1.2 - 1.25 - 1.5 - 2 - 2.5 - 3 - 4 - 5 - 6 - 7.5 - 8 (and their decades) closest to the calculated result.

Ip = CT primary current, Up = VT primary voltage, U = direct connected voltage, cos φ = power factor

Electrical system	Formula	Example	End scale value to choose (considering 0,6 to 1.2 x S)
Single-phase, direct voltage connection	$P = U(L-N) \times I_p \times \cos \phi$	$P = 230V \times 50A \times 0.9 = 10350 W = 10.35 kW$	10 kW
3-phase 4-wire, direct voltage connection (balanced or unbalanced)	$P = 3 \times U(L-N) \times I_p \times \cos \phi$	$P = 3 \times 230V \times 400A \times 0.95 = 262200 W = 262.2 kW$	250 kW
3-phase 3-wire, direct voltage connection (balanced or unbalanced)	$P = 1.732 \times U(L-L) \times I_p \times \cos \phi$	$P = 1.732 \times 400V \times 1000A \times 0.9 = 623520 W = 623.52 kW$	600 kW
3-phase 4-wire, voltage connection via VT (balanced or unbalanced)	$P = 3 \times U_p(L-N) \times I_p \times \cos \phi$	$P = 3 \times 5770V \times 100A \times 0.95 = 1644450 W = 1.64445 MW$	1.5 MW
3-phase 3-wire, voltage connection via VT (balanced or unbalanced)	$P = 1.732 \times U_p(L-L) \times I_p \times \cos \phi$	$P = 1.732 \times 30000V \times 50A \times 0.9 = 2338200 W = 2.3382 MW$	2,5 MW

- 5) Select pulse rate: 1p/10kWh,
- 6) Select output: 1 puls. o/p

### 3-phase 3-wire balanced or unbalanced

- 1) Select type: M244-HWJ-S,
- 2) Specify input voltage and CT ratio: 400V L-L, 1000/1A,
- 3) Spec. scaling: 0-600 kW,
- 4) Spec. frequency: 50/60 Hz ,
- 5) Select pulse rate: 1p/10kWh,
- 6) Select output: 1 puls. o/p

### 3-phase 4-wire balanced or unbalanced, VT connected

- 1) Select type: M244-HWU-S,

- 2) Specify VT ratio and CT ratio: 5770/57.7V L-N, 100/5A,
- 3) Spec. scaling: 0-1.5 MW,
- 4) Spec. frequency: 50/60 Hz,
- 5) Select pulse rate: 1p/100kWh,
- 6) Select output: 1 pulsed output

### 3-phase 3-wire balanced or unbalanced

- 1) Select type: M244-HWD-S,
- 2) Specify input VT ratio and CT ratio: 30000/110V L-L, 50/1A,
- 3) Spec. scaling: 0-2.5MW 4) spec. frequency: 50/60 Hz, 5) select pulse rate: 1p/100kWh,
- 4) Select output: 1 pulsed output



# REACTIVE ENERGY METER WITH POWER INDICATOR



### Features

- Counts electrical reactive energy and indicates reactive power of electrical systems
- Several voltage ranges available
- Current connection via “through hole” CT on the instrument. No need to interrupt wiring from CT
- Pulsed output as standard

### Benefits

- High visibility
- Terminal cover included
- Low self consumption
- Separated power supply

### Applications

- AC switchgears, panels and distribution boards
- Control boards
- Generator sets

### Construction

- Instruments operate on a fast sampling method of input quantities (current and voltage) of the connected phases
- Meters include “through hole” CT connection, voltage dividers, internal microprocessor and power supply unit
- Slot in screw fixing

### Standards

- CE marked
- BV approved

### Order data/examples

- Single-phase**
- 1) Select type: M244-HXG-S,
  - 2) Specify input voltage and CT ratio: 230V L-N, 50/5A,
  - 3) Spec. scaling: 0-6kvar,
  - 4) Spec. frequency: 50/60 Hz,
  - 5) Select pulse rate: 1p/10kvarh,
  - 6) Select output: 1 pulsed output
- 3-phase 4-wire balanced or 3-phase 4-wire unbalanced**
- 1) Select type: M244-HXK-S,
  - 2) Specify input voltage and CT ratio: 230 V L-N, 400/5A,
  - 3) Spec. scaling: 0-200kvar,

### General Specification

- Accuracy class reactive power meter - 1.5
- Accuracy class reactive energy meter - 2 to EN 62053-23
- Maximum continuous overload - 2 x I<sub>n</sub>, 1.2 x U<sub>n</sub>
- Nominal frequency - 50/60 Hz
- Voltage burden - <0.1VA per phase
- Current burden - <0.1VA per phase
- Power supply - 20-300 VDC / 48-276 VAC
- Frequency - 40-65 Hz
- Voltage burden - <3 VA
- Pulsed output - 1 SO pulsed output with 1p/10kWh, 1p/100kWh, 1p/10MWh, 1p/100MWh. Maximum pulse rate may not exceed 33 pulses per second (1980 pulses per minute). If in doubt choose next higher value, e.g. 1p/100/kWh instead of 1p/10kWh

### Product Codes

Bezel size (mm)	96	96	96	96	96
Scale length (mm)	95	95	95	95	95
Reactive energy meter with Varmeter 90°	M244-HXG-S Single-phase	M244-HXH-S 3P/3W balanced	M244-HXV-S 3P/4W balanced	M244-HXJ-S 3P/3W unbalanced	M244-HXK-S 3P/4W unbalanced
Bezel size (mm)	96	96	96	96	96
Scale Length (mm)	135	135	135	135	135
Reactive energy meter with Varmeter 240°	M244-HXB-S Single-phase	M244-HXC-S 3P/3W balanced	M244-HXU-S 3P/4W balanced	M244-HXD-S 3P/3W unbalanced	M244-HXE-S 3P/4W unbalanced
<b>Standard input ranges</b>					
Single-phase, 3P/4W balanced & unbalanced	57.7V L-N/1A, 57.7V L-N/5A, 63.5V L-N/1A, 63.5V L-N/5A, 230V L-N/1A, 230V L-N/5A, 240V L-N/1A, 240V L-N/5A, 254V L-N/1A, 254V L-N/5A,				
3P/3W balanced & unbalanced	100V L-L/1A, 100V L-L/5A, 110V L-L/1A, 110V L-L/5A, 400V L-L/1A, 400V L-L/5A, 415V L-L/1A, 415V L-L/5A, 440V L-L/1A, 440V L-L/5A				

### Calculation of end scale value

End scale value is calculated using the formula below, where correct voltage must be selected (either L-N or L-L), depending on the electrical system and the type of meter used. Scale factor, e.g. the relation between end scale value and nominal apparent power (cos-phi = 1) must be between 0.6 to 1.2. It is recommended selecting the scale value from 1 - 1.2 - 1.25 - 1.5 - 2 - 2.5 - 3 - 4 - 5 - 6 - 7.5 - 8 (and their decades) closest to the calculated result..

I<sub>p</sub> = CT primary current, U<sub>p</sub> = VT primary voltage, U = direct connected voltage, sin φ = power factor

Electrical system	Formula	Example	End scale value to choose (considering 0,6 to 1.2 x S)
Single-phase, direct voltage connection	$P = U(L-N) \times I_p \times \sin \phi$	$Q = 230V \times 50A \times 0,44 = 5060 \text{ var} = 5.06 \text{ kvar}$	6 kvar
3-phase 4-wire, direct voltage connection (balanced or unbalanced)	$P = 3 \times U(L-N) \times I_p \times \sin \phi$	$P = 3 \times 230V \times 400A \times 0,31 = 85560 \text{ var} = 85.56 \text{ kvar}$	200 kvar
3-phase 3-wire, direct voltage connection (balanced or unbalanced)	$P = 1.732 \times U(L-L) \times I_p \times \sin \phi$	$P = 1.732 \times 400V \times 1000A \times 0,44 = 304832 \text{ var} = 304.8 \text{ kvar}$	500 kvar
3-phase 4-wire, voltage connection via VT (balanced or unbalanced)	$P = 3 \times U_p(L-N) \times I_p \times \sin \phi$	$P = 3 \times 5770V \times 100A \times 0,199 = 344469 \text{ var} = 344.469 \text{ kvar}$	1 Mvar
3-phase 3-wire, voltage connection via VT (balanced or unbalanced)	$P = 1.732 \times U_p(L-L) \times I_p \times \sin \phi$	$P = 1.732 \times 30000V \times 50A \times 0,44 = 1143120 \text{ var} = 1.14312 \text{ Mvar}$	2 Mvar

- 4) Spec. frequency: 50/60 Hz,
  - 5) Select pulse rate: 1p/10kvarh,
  - 6) Select output: 1 pul. O/P
- 3-phase 3-wire balanced or unbalanced**
- 1) Select type: M244-HXJ-S,
  - 2) Spec. input voltage and CT ratio: 400V L-L, 1000/1A,
  - 3) Spec. scaling: 0-500 kvar,
  - 4) Spec. frequency: 50/60 Hz ,
  - 5) Select pulse rate: 1p/10kvarh,
  - 6) Select output: 1 pul. O/P
- 3-phase 4-wire balanced or unbalanced, VT connected**
- 1) Select type: M244-HXU-S,
  - 2) Specify VT ratio and CT ratio: 5770/57.7V L-N, 100/5A,
  - 3) Spec. scaling: 0-1 Mvar,
  - 4) Spec. frequency: 50/60 Hz,
  - 5) Select pulse rate: 1p/100kvarh,
  - 6) Select output: 1 pul. O/P
- 3-phase 3-wire balanced or unbalanced**
- 1) Select type: M244-HXD-S,
  - 2) Specify input VT ratio and CT ratio: 30000/110V L-L, 50/1A,
  - 3) Spec.scaling: 0-2 Mvar
  - 4) Spec. frequency: 50/60 Hz,
  - 5) Select pulse rate: 1p/100kWh,
  - 6) Select output: 1 pulsed O/P

# WIRING DIAGRAMS ENERGY METERS



## Single-phase, direct or VT voltage connection

Active Energy Meter M244-HWG-S  
 Active Energy Meter M244-HWB-S  
 Reactive Energy Meter M244-HXG-S  
 Reactive Energy Meter M244-HXB-S

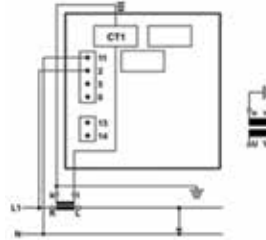

Power supply:  
 Terminal 13 and 14  
 Pulsed output:  
 Terminal 15 and 16



## 3-phase 3-wire balanced, direct or VT voltage connection

Active Energy Meter M244-HWH-S  
 Active Energy Meter M244-HWC-S  
 Reactive Energy Meter M244-HXH-S  
 Reactive Energy Meter M244-HXC-S

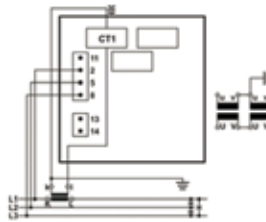

Power supply:  
 Terminal 13 and 14  
 Pulsed output:  
 Terminal 15 and 16

## 3-phase 4-wire balanced, direct or VT voltage connection

Active Energy Meter M244-HWV-S  
 Active Energy Meter M244-HWU-S  
 Reactive Energy Meter M244-HXV-S  
 Reactive Energy Meter M244-HXU-S

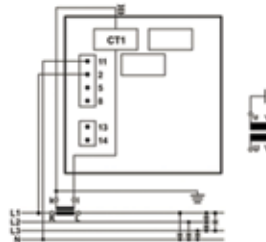

Power supply:  
 Terminal 13 and 14  
 Pulsed output:  
 Terminal 15 and 16

## 3-phase 3-wire unbalanced, direct or VT voltage connection

Active Energy Meter M244-HWJ-S  
 Active Energy Meter M244-HWD-S  
 Reactive Energy Meter M244-HXJ-S  
 Reactive Energy Meter M244-HXD-S

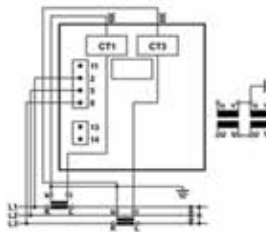

Power supply:  
 Terminal 13 and 14  
 Pulsed output:  
 Terminal 15 and 16

## 3-phase 4-wire unbalanced, direct or VT voltage connection

Active Energy Meter M244-HWK-S  
 Active Energy Meter M244-HWE-S  
 Reactive Energy Meter M244-HXK-S  
 Reactive Energy Meter M244-HXE-S

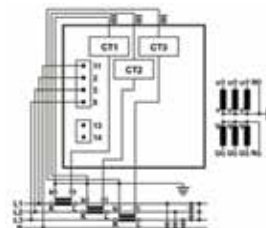

Power supply:  
 Terminal 13 and 14  
 Pulsed output:  
 Terminal 15 and 16

# SYNCHRONOSCOPE



## Features

- Typically used to measure between Busbar and Generator
- Available as LED indicator only, LED indicator with LCD display, LED indicator with synchro check relay, LED indicator with LCD display and Synchro check relay

## Benefits

- Supports damage prevention on expensive assets
- Simple synchronisation conditions setting
- High visibility
- Terminal cover included
- Low self consumption
- Up to five meters in one unit

## Applications

- Used on manual and semi-automatic synchronising applications
- AC switchgears, panels and distribution boards
- Generator sets

## Construction

- Instruments are microprocessor based
- Slot in screw fixing

## Standards

- CE marked
- BV approved

## General Specification

### Synchronising functions

- Voltage difference setting ( $\Delta U$ ) - 1.5
- Accuracy - +/- 2.5%
- Phase difference setting - 2 ... 20° el.
- Accuracy - +/- 3° el.
- Time delay synchronisation - 0.1 ... 1 s.
- Accuracy - +/- 10%
- Synchronisation pulse duration - 300 ms
- Accuracy - +/- 30 ms
- Nominal frequency range - 45/65 Hz
- Output relay specification - 250V, 6A, 50 Hz, 1500 VA
- Voltage burden - <4 VA
- Overload - 1.2 x Un permanently, 2 x Un for 3s

### LED functions

- Resolution  $\Delta \phi$  display - 20° el.
- Magnified resolution range - +/- 15° el.
- Magnified resolution - 5° el.
- Accuracy at  $\Delta \phi = 0$  - +/- 3° el.

### LCD functions

- Accuracy voltage display - +/- 1.5%
- Accuracy frequency display - +/- 0.5%
- Phase difference accuracy Ugen to Ubb - +/- 3° el.

## Product Codes

Bezel size (mm)	96	96	96
	M244-14A-S LED only	M244-14L-S LED & synchro check relay	M244-14D-S LED & synchro check relay with deadbus option
Bezel size (mm)	96	96	96
	M244-14B-S LED only	M244-4M-S LED & synchro check relay & LCD	M244-14E-S LED & synchro check relay with deadbus option & LCD display

### Standard input ranges

Voltage	100V L/L, 110V L/L/400V L/L, 415 V L/L, 440V L/L
---------	--

## Order data/examples

- 1) Select type: M244-14M-S,
- 2) Specify input voltage: 415V,
- 3) Specify display or output: Relay output,
- 4) Specify frequency: 45-65 Hz,
- 5) Specify functional description: Output duration 300ms

## Connection Diagrams

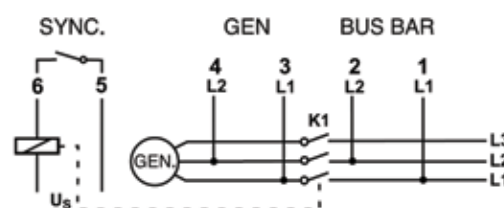

## Product Dimensions

Description		M242-01*, M242-02*, M242-05*	M243-01*, M243-02*, M243-05*	M244-01*, M244-02*, M244-05*, M244-41R*, M244-41E*, M244-41L*, M244-41D*, M244-41S*, M244-80*, M244-12*	M246-01*, M246-02*, M246-05*
Bezel (mm)	a	48	72	96	144
Panel cut out (mm)	b	45 (+0.6)	68 (+0.8)	92 (+0.8)	138 (+1.0)
Bezel height (mm)	c	5.0	5.5	5.5	8.0
Terminal cover (mm)	d	42.5	66.5	90	90

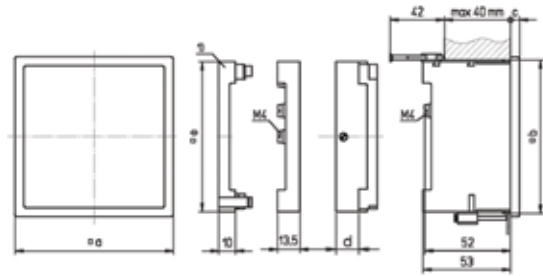
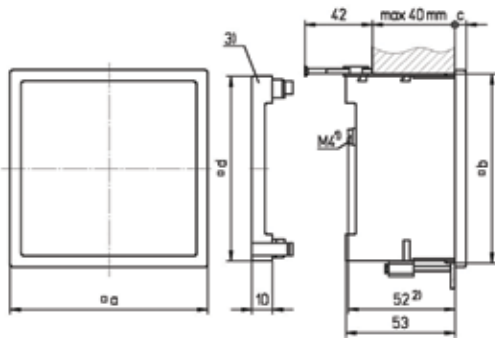

M242-01\*, M242-02\*, M242-05\*, M243-01\*, M243-02\*,  
M243-05\*, M244-01\*, M244-02\*, M244-41R\*, M244-41E\*,  
M244-05\*, M244-12\*, M246-01\*, M246-02\*, M246\*-05\*

M244-41L\*, M244-41D\*, M244-41S\*, M244-80\*  
(d = 27.3 mm)

2) 59 mm on current ratings 30 to 60A

Description		M244-13*, M244-42*, M244-21*, M244-31*	M244-HW*, M244-HX*	M244-14*
Bezel (mm)	a	96	96	96
Panel cut out (mm)	b	92 (+0.8)	92 (+0.8)	92 (+0.8)
Bezel height (mm)	c	5.5	5.5	5.5

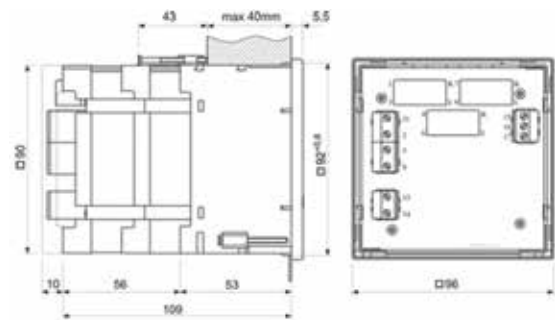
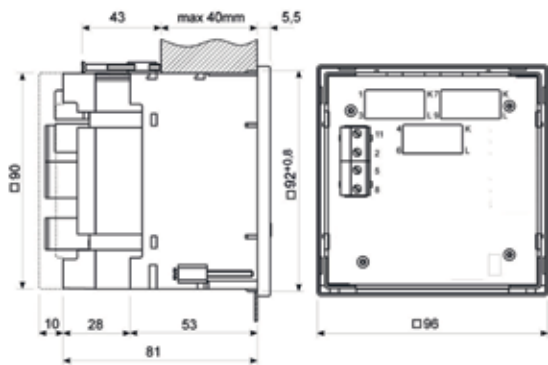

M244-13\*, M244-42\*, M244-21\*, M244-31\*

M244-HW\*, M244-HX\*

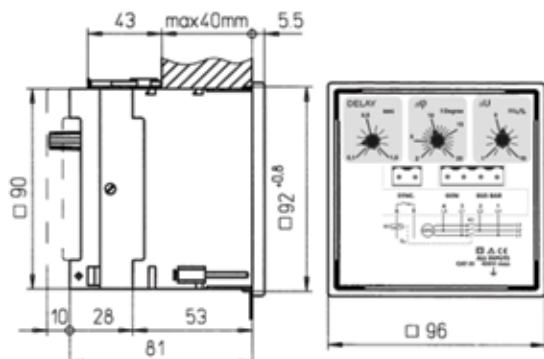

## Technical Details

<b>Type</b>	M242-01* M242-02*	M243-01* M243-02*	M244-01* M244-02*	M246-01* M246-02*	M242-05*	M243-05*	M244-05*	M246-05*	M243-02Q*	M244-02E* M244-02Q*
Weight (kg)	0.14	0.18	0.2	0.4	0.15	0.19	0.25	0.39	0.22	0.32
<b>Type</b>	M244- 1S* M244- 1L*	M244- 1R*	M244- 1E* M244-41D*	M244-80*	M244-12*	M244-42*	M244-13*	M244-21* M244-31*	M244-HW* M244-HX*	M244-14*
Weight (kg)	0.4	0.4	0.5	0.5	0.4	0.5	0.7	0.5 (short scale) 0.7 (long scale)	0.6	0.53
<b>Type</b>	M242-01* M242-02*	M243-01* M243-02*	M244-01* M244-02*	M246-01* M246-02*	M242-05*	M243-05*	M244-05*	M246-05*	M243-02Q*	M244-02E* M244-02Q*
Materials (case /base)	Poly-carbonate, Grade UL94V0	Poly-carbonate, Grade UL94V0	Poly-carbonate, Grade UL94V0	Poly-carbonate, Grade UL94V0	Poly-carbonate, Grade UL94V0	Poly-carbonate, Grade UL94V0	Poly-carbonate, Grade UL94V0	Poly-carbonate, Grade UL94V0	Poly-carbonate, Grade UL94V0	Poly-carbonate, Grade UL94V0
<b>Type</b>	M244-41S* M244-41L*	M244-41R*	M244-41E* M244-41D*	M244-80*	M244-12*	M244-42*	M244-13*	M244-21* M244-31*	M244-HW* M244-HX*	M244-14*
Materials (case /base)	Poly-carbonate, Grade UL94V0	Poly-carbonate, Grade UL94V0	Poly-carbonate, Grade UL94V0	Poly-carbonate, Grade UL94V0	Poly-carbonate, Grade UL94V0	Poly-carbonate/ABS, Grade UL94V0	Poly-carbonate/ABS, Grade UL94V0	Poly-carbonate/ABS, Grade UL94V0	Poly-carbonate/ABS, Grade UL94V0	Poly-carbonate/ABS, Grade UL94V0
<b>Type</b>	M242-01* M242-02*	M243-01* M243-02*	M244-01* M244-02*	M246-01* M246-02*	M242-05*	M243-05*	M243-05* M244-05*	M246-05*	M243-02Q*	M244-02E* M244-02Q*
Temperature: Reference Range Stocking	+18/+28°C -25/+55°C -40/+70°C	+18/+28°C -25/+55°C -40/+70°C	+18/+28°C -25/+55°C -40/+70°C	+18/+28°C -25/+55°C -40/+70°C	+18/+28°C -25/+55°C -40/+70°C	+18/+28°C -25/+55°C -40/+70°C	+18/+28°C -25/+55°C -40/+70°C	+18/+28°C -25/+55°C -40/+70°C	+18/+28°C -25/+55°C -40/+70°C	+18/+28°C -25/+55°C -40/+70°C
<b>Type</b>	M244-41S* M244-41L*	M244-41R*	M244-41E* M244-41D*	M244-80*	M244-12*	M244-42*	M244-13*	M244-21* M244-31*	M244-HW* M244-HX*	M244-14*
Temperature: Reference Range Stocking	+18/+28°C -25/+55°C -40/+70°C	+18/+28°C -25/+55°C -40/+70°C	+18/+28°C -25/+55°C -40/+70°C	+18/+28°C -25/+55°C -40/+70°C	+18/+28°C -25/+55°C -40/+70°C	+18/+28°C -25/+55°C -40/+70°C	+18/+28°C -25/+55°C -40/+70°C	+23°C -10/+55°C -40/+70°C	+23°C -10/+55°C -40/+70°C	0/50°C -20/+55°C -40/+70°C
<b>Type</b>	M242-01* M242-02*	M243-01* M243-02*	M244-01* M244-02*	M246-01* M246-02*	M242-05*	M243-05*	M244-05*	M246-05*	M243-02Q*	M244-02E* M244-02Q*
Relative humidity (none condensing)	up to 80%	up to 80%	up to 80%	up to 80%	up to 80%	up to 80%	up to 80%	up to 80%	up to 80%	up to 80%
<b>Type</b>	M244-41S* M244-41L*	M244-41R*	M244-41E* M244-41D*	M244-80*	M244-12*	M244-42*	M244-13*	M244-21* M244-31*	M244-HW* M244-HX*	M244-14*
Relative humidity (none condensing)	up to 80%	up to 80%	up to 80%	up to 80%	up to 80%	up to 80%	up to 80%	up to 75%	up to 75%	up to 95%
<b>Type</b>	M242-01* M242-02*	M243-01* M243-02*	M244-01* M244-02*	M246-01* M246-02*	M242-05*	M243-05*	M244-05*	M246-05*	M243-02Q*	M244-02E* M244-02Q*
Terminals	M4	M4 (M6 from (15) 30 to 60A)	M4 (M6 from (15) 30 to 60A)	M4 (M6 from (15) 30 to 60A)	M4	M4	M4	M4	M4	M4
<b>Type</b>	M244-41S* M244-41L*	M244-41R*	M244-41E* M244-41D*	M244-80*	M244-12*	M244-42*	M244-13*	M244-21* M244-31*	M244-HW* M244-HX*	M244-14*
Terminals	M4	M4	M4	M4	M4	Volts: 2.5mm2 Amps: d = 6mm Other: 2.5mm2	Volts: 2.5mm2 Amps: d = 6mm Other: 2.5mm2	Volts: 2.5mm2 Amps: d = 6mm Other: 2.5mm2	Volts: 2.5mm2 Amps: d = 6mm Other: 2.5mm2	Volts: 2.5mm2 Amps: d = 6mm Other: 2.5mm2
<b>Type</b>	M242-01* M242-02*	M243-01* M243-02*	M244-01* M244-02*	M246-01* M246-02*	M242-05*	M243-05*	M244-05*	M246-05*	M243-02Q*	M244-02E* M244-02Q*
IP front IP back **	IP 52 IP 00	IP 52 IP 00	IP 52 IP 00	IP 52 IP 00	IP 52 IP 00	IP 52 IP 00	IP 52 IP 00	IP 52 IP 00	IP 52 IP 00	IP 52 IP 00
<b>Type</b>	M244-41S* M244-41L*	M244-41R*	M244-41E* M244-41D*	M244-80*	M244-12*	M244-42*	M244-13*	M244-21* M244-31*	M244-HW* M244-HX*	M244-14*
IP front IP back **	IP 52 IP 00	IP 52 IP 00	IP 52 IP 00	IP 52 IP 00	IP 52 IP 00	IP 52 IP 00	IP 52 IP 00	IP 52 IP 00	IP 52 IP 00	IP 52 IP 00

\* denotes an abbreviation of the catalogue number as shown on previous pages , \*\* without terminal cover

## Technical Details

Type	M242-01* M242-02*	M243-01* M243-02*	M244-01* M244-02*	M246-01* M246-02*	M242-05*	M243-05*	M244-05*	M246-05*	M243-02Q*	M244-02E* M244-02Q*
Mounting position	Vertical	Vertical	Vertical	Vertical	Vertical	Vertical	Vertical	Vertical	Vertical	Vertical
Type	M244-41S* M244-41L*	M244-41R*	M244-41E* M244-41D*	M244-80*	M244-12*	M244-42*	M244-13*	M244-21* M244-31*	M244-HW* M244-HX*	M244-14*
Mounting position	Vertical	Vertical	Vertical	Vertical	Vertical	Vertical	Vertical	Vertical	Vertical	Vertical
Type	<p>M243-02*, M244-02*, M246-02*, M244-02Q*, M244-80L*, M244-12P*</p> <p>M242-01V*, M243-01V*, M244-01V*, M246-01V*, M242-05V*, M243-05V*, M244-05V*, M246-05V*, M244-05V*, M246-05V*, M242-01W*, M243-01W*, M244-01W*, M246-01W*, M242-05W*, M243-05W*, M244-05W*, M246-05W*, (only inputs 300-600V)</p> <p>M242-01N*, M243-01N*, M244-01N*, M246-01N*, M242-05N*, M243-05N*, M244-05N*, M246-05N*, (only inputs 150-300V)</p>					<p>M242-02*</p> <p>M242-01V*, M243-01V*, M244-01V*, M246-01V*, M242-05V*, M243-05V*, M244-05V*, M246-05V*, M242-01W*, M243-01W*, M244-01W*, M246-01W*, M242-05W*, M243-05W*, M244-05W*, M246-05W* (all inputs other than 300-600V)</p> <p>M242-01N*, M243-01N*, M244-01N*, M246-01N*, M242-05N*, M243-05N*, M244-05N*, M246-05N*, (all inputs other than 150-300V)</p> <p>M242-01A*, M243-01A*, M244-01A*, M246-01A*, M242-01C*, M243-01C*, M244-01C*, M246-01C*, M242-01R*, M243-01R*, M244-01R*, M246-01R*, M242-01S*, M243-01S*, M244-01S*, M246-01S*,</p> <p>M242-05A*, M243-05A*, M244-05A*, M246-05A*, M242-05C*, M243-05C*, M244-05C*, M246-05C*, M242-05R*, M243-05R*, M244-05R*, M246-05R*, M242-05S*, M243-05S*, M244-05S*, M246-05S*,</p> <p>M244-80E*, M244-21*, M244-31*, M244-42*, M244-136*, M244-HW*, M244-HX*, M244-41*</p>				M244-14*
Installation category (Vrms)	CAT III 600V					CAT II 600V / CAT III 300V				CAT III 400V
Test voltage (specified for double or reinforced insulation)	5,2 kV					3,7 kV				5,2 kV

## Applicable Standards

Type	M242-02* M243-02* M244-02* M246-02*	M242-01* M243-01* M244-01* M246-01* (except moving coil rectified)	M242-05* M243-05* M244-05* M246-05* (except moving coil rectified)	M242-01B*, M243-01B*, M244-01B*, M246-01B*, M242-01W*, M243-01W*, M244-01W*, M246-01W*, M242-05B*, M243-05B*, M244-05B*, M246-05B*, M242-05W*, M243-05W*, M244-05W*, M246-05W*, M244- 2E*, M244-12P*	M243-01Q* M244-01Q*	E244-41S* E244-41L* E244-41D*	E244-41R E244-41E
Standards	EN 60051-1 EN 60051-2 EN 60051-9 EN 61326-1 EN 61010-1	EN 60051-1 EN 60051-2 EN 60051-9 EN 61010-1 EN 61326-1	EN 60051-1 EN 60051-2 EN 60051-9 EN 61010-1 EN 61326-1	EN 60051-1 EN 60051-2 EN 60051-9 EN 61010-1 EN 61326-2	EN60051-1 EN60051-9 EN61010-1	EN 60051-1 EN 60051-4 EN 60051-9 EN 61010-1 EN 61326-1	EN 60051-1 EN 60051-4 EN 60051-9 EN 61010-1 EN 61326-1
Type	M244-21* M244-31*	M244-13* M244-42*	M244-HW* M244-HX*	M244-14*	M244-80L*		
Standards	EN 60051-1 EN 60051-5 EN 60051-9 EN 61010-1 EN 61326-1	EN 60051-1 EN 60051-3 EN 60051-9 EN 61010-1 EN 61326-1	EN 60051-1 EN 60051-3 EN 60051-9 EN 61010-1 EN 61326-1	EN 60051-5 EN 61010-1 EN 61326-1	EN 60051-1 EN 60051-4 EN 60051-9 EN 61010-1 EN 61326-1		

\* denotes an abbreviation of the catalogue number as shown on previous pages.

## BV Approvals

Type	M24*-02**,-S, M244-02Q-S, M244-80-L-S, M244-12-P-S	M244-21*-S, M244-31*-S, M244-42*-S, M244-13*-S, M24*-01**,-S, M24*-05**,-S, M244-H*x-S, M24*-01**,-S, M244-02E-S, M24*-05**,-S	M244-41R-S, M244-41E-S, M244-41S-S, M244-41L-S, M244-41D-S	M244-14*-S
Certificate number	38933/A0 BV	38940/A0 BV	38941/A0 BV	38942/A0 BV