

Model 142MR

Current Transformer Multi-Ratio Window Diameter 7.25"

Application

Relaying.

Frequency

50-400 Hz.

Insulation Level

600 Volt, 10 kV BIL full wave.

The transformer winding is arranged so that the turns are fully distributed between all taps.

Terminals are brass screws No. 10-32 with one flatwasher and lockwasher.

Order mounting bracket kit 0221B00259 separately.

Approximate weight 31 lbs.



Model 142MR

Catalog Number	Relay Class	Continuous Thermal Rating Factor	
		@ 30 °C	@ 55 °C
142-601MR	C50	2.0	2.0
142-122MR	C200	1.5	1.0
142-202MR	C200	2.0	1.5
142-302MR	C200	1.0	0.8
142-402MR	C200	1.0	0.8
142-502MR	C200	1.0	0.8

REGULATORY AGENCY APPROVALS



Manufactured to meet the requirements of ANSI/IEEE C57.13.
Classified by U.L. in accordance with IEC 44-1

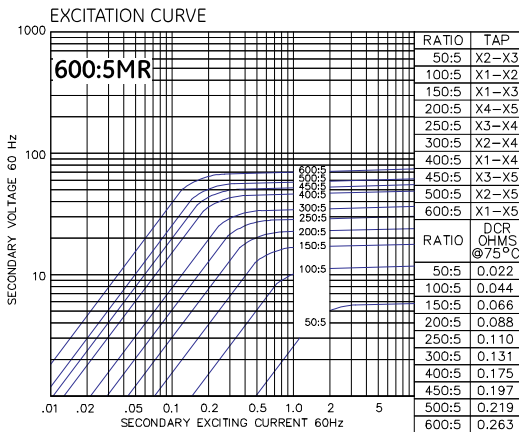

Model 140-601MR

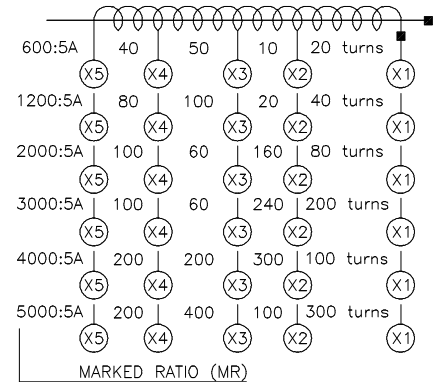

Model 142MR

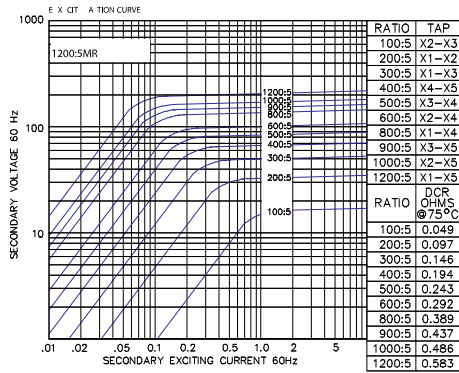

Model 142-122MR

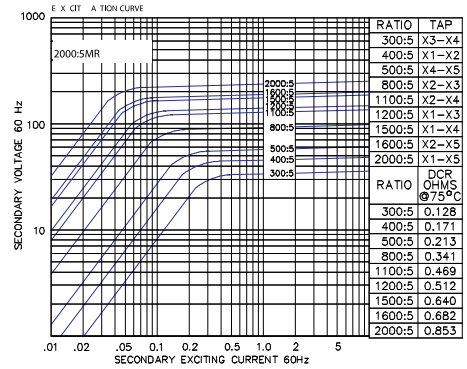

Model 142-202MR

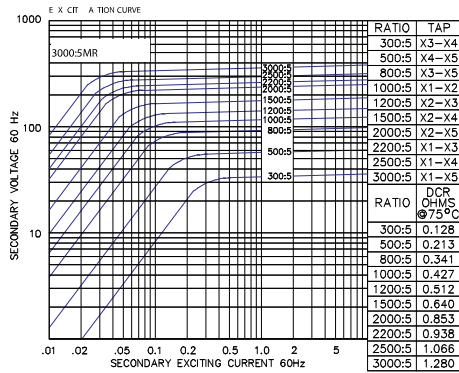

Model 142-302MR

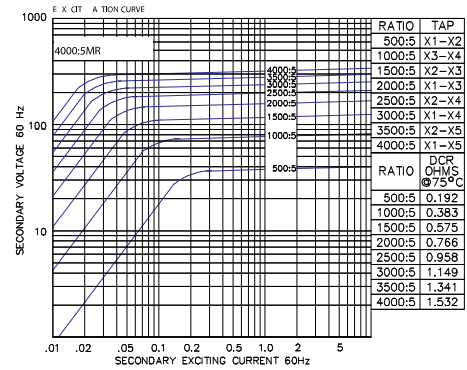

Model 142-402MR

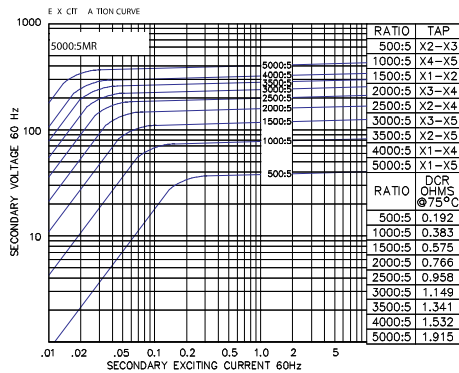

Model 142-502MR

