

# Model 140MR

## Current Transformer Multi-Ratio Window Diameter 8.13"

### Application

Relaying.

### Frequency

50-400 Hz.

### Insulation Level

600 Volt, 10 kV BIL full wave.

### Model 140MR

Terminals are brass screws No. 10-32 with one flatwasher and lockwasher.

The transformer winding is arranged so that the turns are fully distributed between all taps.

Order mounting bracket kit 0221B00259 separately.

Approximate weight 23 lbs.



Catalog Number	Relay Class	Continuous Thermal Rating Factor	
		@ 30 °C	@ 55 °C
140-601MR	C50	2.0	2.0
140-122MR	C100	1.5	1.5
140-202MR	C100	1.33	1.0
140-302MR	C100	1.0	0.8
140-402MR	C200	1.0	0.8
140-502MR	C50	1.0	0.8

#### REGULATORY AGENCY APPROVALS



Manufactured to meet the requirements of ANSI/IEEE C57.13.  
Classified by U.L. in accordance with IEC 44-1

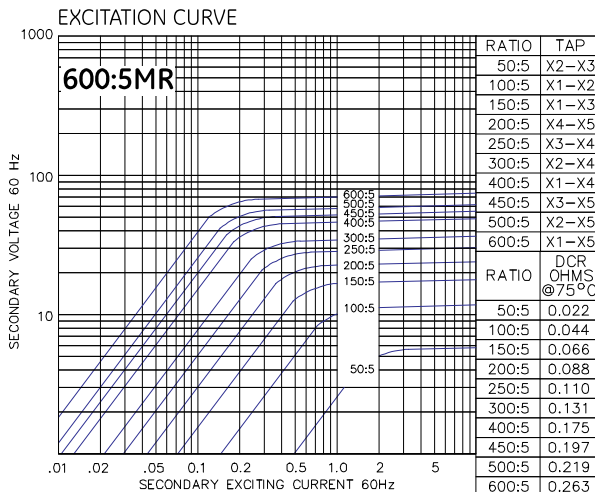

Model 140-601MR

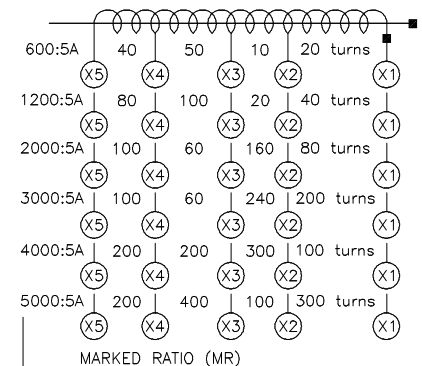

## Model 140MR

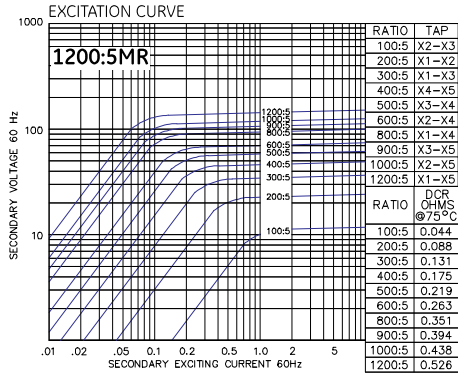

Model 140-122MR

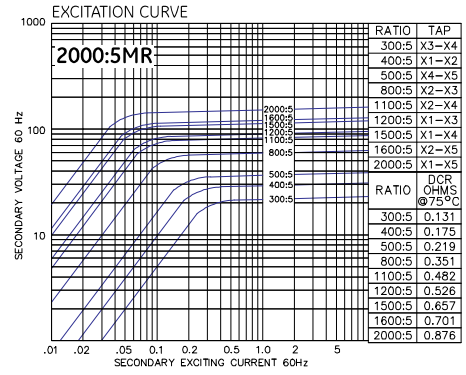

Model 140-202MR

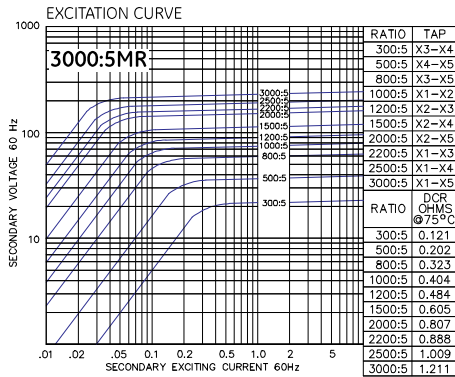

Model 140-302MR

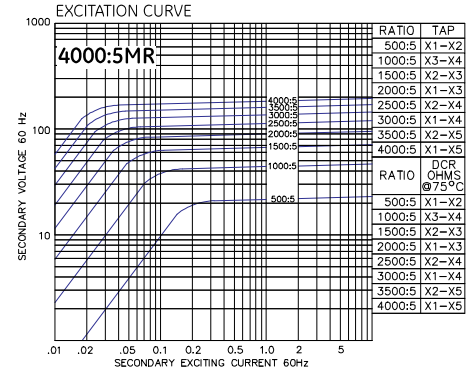

Model 140-402MR

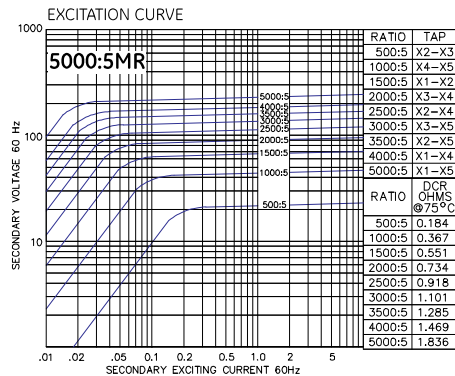

Model 140-502MR

