

# Model 141MR

## Current Transformer Multi-Ratio Window Diameter 8.13"

### Application

Relaying.

### Frequency

50-400 Hz.

### Insulation Level

600 Volt, 10 kV BIL full wave.

Terminals are brass screws No. 10-32 with one flatwasher and lockwasher.

The transformer winding is arranged so that the turns are fully distributed between all taps.

Order mounting bracket kit 0221B00775 separately.

Approximate weight 45 lbs.



### Model 141MR

Catalog Number	Relay Class	Continuous Thermal Rating Factor	
		@ 30 °C	@ 55 °C
141-601MR	C100	2.0	1.5
141-122MR	C200	2.0	1.5
141-202MR	C400	1.33	1.0
141-302MR	C400	1.5	1.33
141-402MR	C400	1.0	0.8
141-502MR	C200	1.0	0.8

#### REGULATORY AGENCY APPROVALS



Manufactured to meet the requirements of ANSI/IEEE C57.13. Classified by U.L. in accordance with IEC 44-1

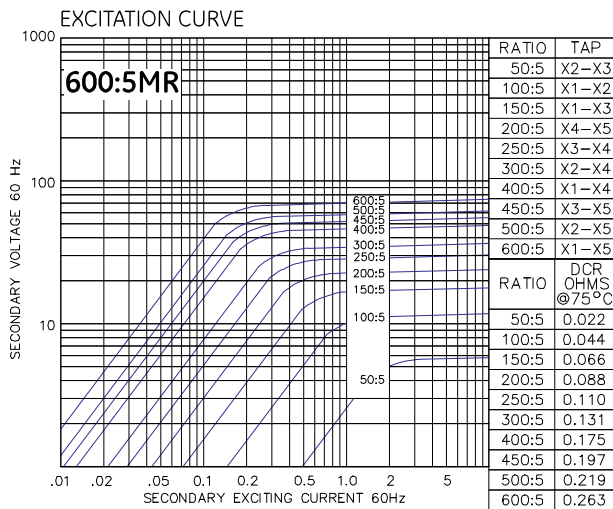

Model 140-601MR

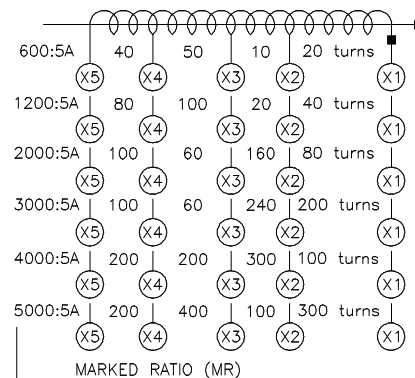

## Model 141MR

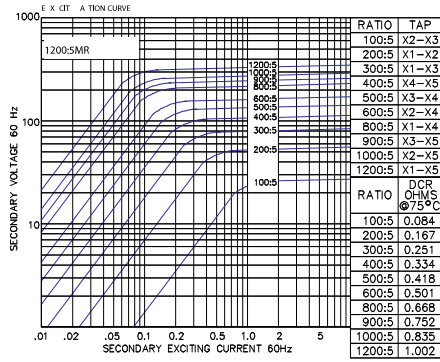

Model 141-12MR

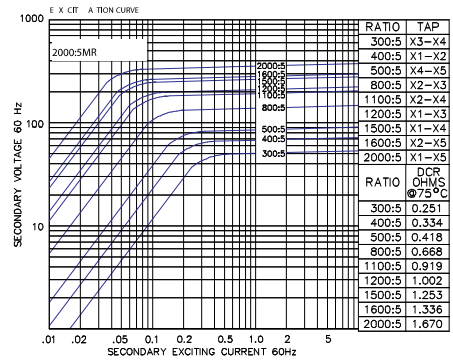

Model 141-20MR

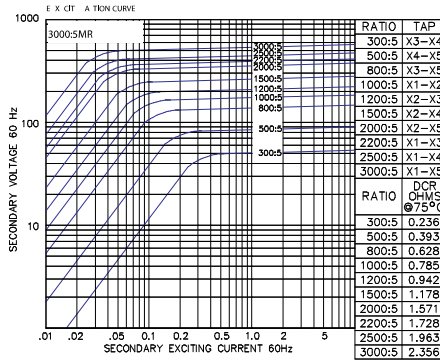

Model 141-30MR

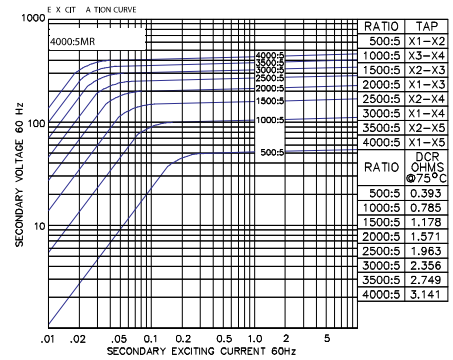

Model 141-40MR

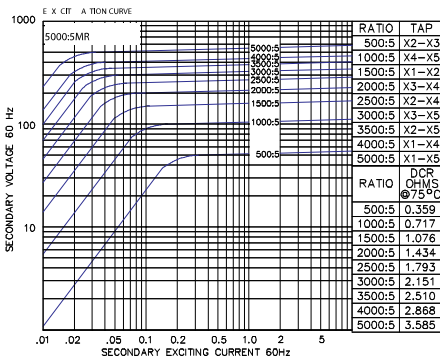

Model 141-50MR

