

Installation and Operating Instructions

Integra Ri3

DIN-rail digital meter for single and three-phase electrical systems





Introduction

This unit measures and displays the characteristics of single-phase two-wire, three-phase three-wire and three-phase four-wire supplies, including voltage, frequency, current, power and real and reactive energy, imported and exported.

For more in-depth operating instructions, please refer to the full manual that is available on the Crompton Instruments website, at www.crompton-instruments.com.

Measurement

In measurement mode, the buttons control the displayed measurement as follows:



	<p>Selects the Voltage and Frequency display screens. Successive operations of the button select voltage, frequency and %THD (Total Harmonic Distortion). In Set-up mode, this is the 'Back' button.</p>
	<p>Selects the Current display screens. Successive operations select phase and neutral (3ph4w) currents, max. demanded currents and current %THD. In Set-up mode, this is the 'Up' button.</p>
	<p>Selects the Instantaneous Power screens. Successive operations select power (W, VAR & VA), max. demanded power and power factor. In Set-up mode, this is the 'Down' button.</p>
	<p>Selects the Energy display screens. Successive operations select imported/exported Wh and Varh. Display can indicate up to 9999999.9. Running man symbol flashes as data accumulates. 1% symbol shows that power values of <1% of range maximum will be included in energy readings. In Set-up mode, this is the 'Enter' button.</p>

Display shows the units of measurements in use for each range. Energy units can be set via set-up screens; other units are set automatically.

A Demand Reset resets maximum demand readings to zero.

Setting up

To enter set-up mode, firmly press the  and  buttons simultaneously and hold for 5 seconds, until the password screen appears. Setting up is password-protected so you must enter the correct password (default '0000') before proceeding. If an incorrect password is entered, the display reverts to measurement mode.

To exit setting-up mode, press  repeatedly until the measurement screen is restored or hold  and  buttons simultaneously for 5 seconds.

Setup Menu Structure

Change password

nnnn – 4-digit number, default '0000'.

Supply system

3-phase 3-wire or 4-wire or single phase.

CT

Set the value of the CT primary in use

nnnn – 4-digit number, 0001 to 9999.

dIT - Demand Integration Time

This is the period in minutes over which the current and power readings are integrated for maximum demand measurement.

Options are: Off, 5, 8, 10, 15, 20, 30 and 60 minutes.

RSET

Resets cumulative Energy and/or Demand measurements to zero.

COMS

Communication parameters for RS485 interface:

FMT – Format:

Modb

Modbus protocol,

Baud rate 2400/4800/9600/19200/38400

Parity none/odd/even

Stop bits 1 (1 or 2 if parity is None)

Network address *nnn* – 3-digit number, 1 to 247

Order: Norm/Rev – Indicates Modbus word order.

N2

Johnson Controls (JC) N2 protocol,

Network address *nnn* – 3-digit number, 1 to 255.

Rly - Relay pulse output

kWh/kVArh (Active/reactive) Import or Export

Rate 0.001/0.01/0.1/1/10/100/1k/10k kWh or kVArh per pulse

Pulse width 200/100/60 ms.

NRGy - Energy

Unit/kilo/Mega units selection

1% limit on/off. If **on**, power values <1% of range max. will not be included in energy measurements (prevents 'creep').

Test

Display on – all elements on to check display











dISTG – Display toggle. Each element is turned on and off

Phase sequence (V123 I123).

SOFT





Displays firmware version and build numbers.

Menu Option Selection

- Use the  (up) and  (down) keys to select the required item from the menu. Selection does not roll over between bottom and top of list.
- Press  to confirm the selection.
- If an item flashes, then it can be adjusted by the  (up) and  (down) keys. If not, there may be a further layer, e.g. Comms - Baud rate, before adjustment is possible. Press  to select the lower layer.
- Having selected an option from the current menu layer, press  to confirm your selection. The SET indicator will appear.
- Having completed a parameter setting, press  to return to a higher menu level. The SET indicator will be removed and you will be able to use the  and  keys for further menu selection.
- On completion of all setting-up, press  repeatedly until the measurement screen is restored.

Number Entry Procedure

When setting up the unit, some screens require the entering of a number. In particular, on entry to the setting up section, a password must be entered. Digits are set individually, from left to right. The procedure is as follows:

- The current digit to be set flashes and is set using the  (up) and  (down) keys.
- Press  to confirm each digit setting. The SET indicator appears after the last digit has been set.
- After setting the last digit, press  to exit the number setting routine. The SET indicator will be removed.

Installation

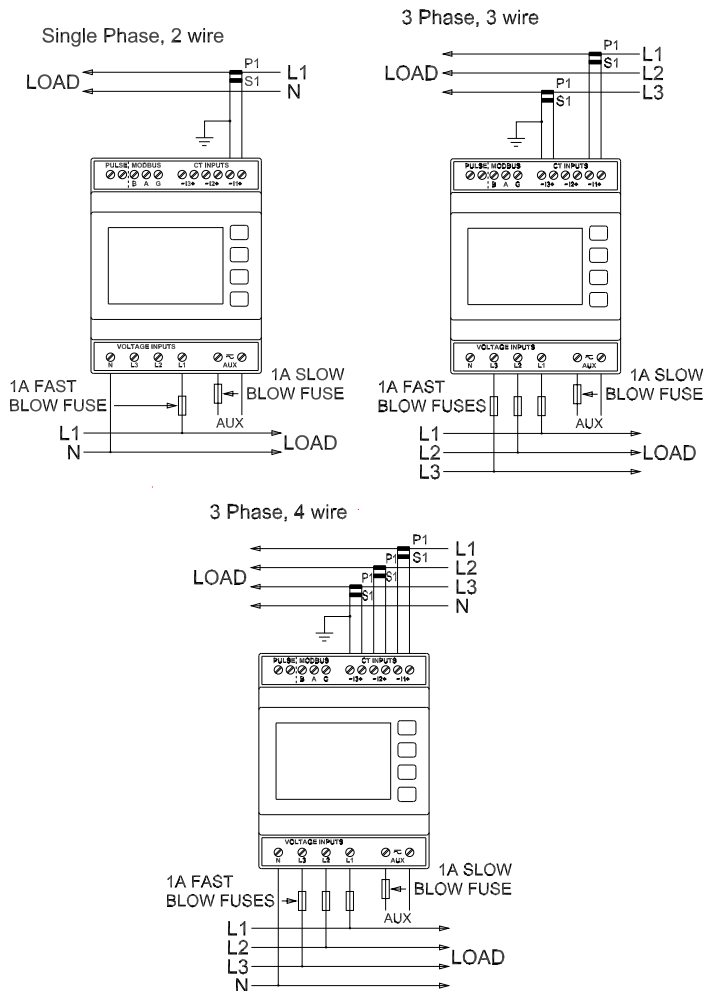

Case Dimensions:

Width 71.3 mm, Depth 57.5 mm, Length 90.5 mm
Length including fixing tag 93.5 mm.

The unit is intended for mounting on a standard DIN rail. Avoid mounting the unit where there is excessive vibration; in excessive direct sunlight; or outside a reasonably stable ambient temperature of -10 to +55°C.

Safety

The unit is designed in accordance with BS EN 61010-1:2001 (IEC 61010-1:2001) – Permanently connected use, Normal condition. Installation category III, pollution degree 2, basic insulation for rated voltage. Measurement Category III.

EMC Installation Requirements

Whilst this unit complies with all relevant EU EMC (electro-magnetic compatibility) regulations, any additional precautions necessary to provide proper operation of this and adjacent equipment will be installation dependent and so the following can only be general guidance:

- Avoid routing wiring to this unit alongside cables and products that are, or could be, a source of interference.
- The auxiliary supply to the unit should not be subject to excessive interference. In some cases, a supply line filter may be required.
- To protect the product against incorrect operation or permanent damage, surge transients must be controlled. It is good EMC practice to suppress transients and surges at the source. The unit has been designed to automatically recover from typical transients; however in extreme circumstances it may be necessary to temporarily disconnect the auxiliary supply for a period of greater than 5 seconds to restore correct operation.
- Screened communication leads are required. These and other connecting leads may require the fitting of RF suppression components, such as ferrite absorbers, line filters etc., if RF fields cause problems.

Warnings



Caution: Risk of Electric Shock

- During normal operation, voltages hazardous to life may be present at some of the terminals of this unit. Installation and servicing should be performed only by qualified, properly trained personnel abiding by local regulations. Ensure all supplies are de-energised before attempting connection or other procedures.
- Terminals should not be user accessible after installation and external installation provisions must be sufficient to prevent hazards under fault conditions.
- This unit is not intended to function as part of a system providing the sole means of fault protection - good engineering practice dictates that any critical function be protected by at least two independent and diverse means.
- The unit does not have internal fuses therefore external fuses must be used for protection and safety under fault conditions.
- Never open-circuit the secondary winding of an energised current transformer.
- This product should only be operated with the CT secondary connections earthed.
- If this equipment is used in a manner not specified by the manufacturer, protection provided by the equipment may be impaired.
- Auxiliary circuits (communication & relay outputs) are separated from metering inputs and 110-400V auxiliary circuits by at least basic insulation. Such auxiliary circuit terminals are only suitable for connection to equipment which has no user accessible live parts. The insulation for such auxiliary circuits must be rated for the highest voltage connected to the instrument and suitable for single fault condition. The connection at the remote end of such auxiliary circuits should not be accessible in normal use. Depending on application, equipment connected to auxiliary circuits may vary widely. The choice of connected equipment or combination of equipment should not diminish the level of user protection specified.

- It is necessary to wind the three current inputs through separate ferrite rings an example part number Wurth 742 701 110, a minimum of 6 times.
- It is good practice to install sensitive electronic instruments that are performing critical functions in EMC enclosures that protect against electrical interference causing a disturbance in function.

Wiring

Input connections are made to screw clamp terminals. Choice of cable should meet local regulations for the operating voltage and current.

The current inputs of these products are designed for connection into systems via current transformers only.

All negative current inputs are commoned inside the unit and grounding should be at one point only. To minimise measurement errors, the CTs should be grounded as shown in the wiring diagram.

CT secondaries must be grounded in accordance with local regulations. It is desirable to make provision for shorting links to be made across CTs to permit easy replacement of a unit should this ever be necessary.

Additional considerations for three wire systems

The neutral terminal (terminal N) is indirectly connected to the voltage input terminals (terminals L1, L2, L3). When connected to a three wire system the neutral terminal will adopt a potential somewhere between the remaining lines.

If external wiring is connected to the neutral terminal it must be connected to either the neutral line or earth (ground) to avoid the possibility of electric shock from the neutral terminal.

Fusing

This unit must be fitted with external fuses in voltage and auxiliary supply lines. Voltage input lines must be fused with a quick blow

fuse 1A maximum. Auxiliary supply lines must be fused with a slow blow fuse rated 1A maximum. Choose fuses of a type and with a breaking capacity appropriate to the supply and in accordance with local regulations.

A suitable switch or circuit breaker should be included in the installation. It should be positioned so as to be easy to operate, in close proximity to the equipment, and clearly identified as the disconnecting device.

Earth/Ground Connections

For safety reasons, current transformer secondary connections should be grounded in accordance with local regulations. Under no circumstances should this product be operated without this earth connection.

Maintenance

In normal use, little maintenance is needed. As appropriate for service conditions, isolate from electrical power, inspect the unit and remove any dust or other foreign material present. Periodically check all connections for freedom from corrosion and screw tightness, particularly if vibration is present.

The front of the case should be wiped with a dry cloth only. Use minimal pressure, especially over the viewing window area. If necessary wipe the rear case with a dry cloth. If a cleaning agent is necessary, isopropyl alcohol is the only recommended agent and should be used sparingly. Water should not be used. If the rear case exterior or terminals should be contaminated accidentally with water, the unit must be thoroughly dried before further service. Should it be suspected that water might have entered the unit, factory inspection and refurbishment is recommended.

In the unlikely event of a repair being necessary, it is recommended that the unit be returned to the factory or nearest Crompton Instruments/Tyco Electronics service centre.

Specification

Measured Parameters

The unit can monitor and display the following parameters of a single phase, 3-phase 3-wire or 3-phase 4-wire supply:

Voltage and Frequency

Phase to neutral voltages 100 to 289V a.c. (not for 3p3w)

Voltages between phases 173 to 500V a.c. (3p only)

Frequency in Hz

Percentage total voltage harmonic distortion (THD%) for each phase to N (not for 3p3w supplies)

Percentage voltage THD% between phases (3p only)

Current

Current on each phase – 1 to 9999A range, set by external current transformer(s) (CTs)

Neutral current (calculated) (3p4w supplies only)

Maximum demand currents on each phase, since the last demand reset

Maximum neutral demand current, since the last demand reset (3p4w supplies only)

Current THD% for each phase

Power and Power Factor

Instantaneous power:

Power 0 to 3600 MW

Reactive Power 0 to 3600 MVA

Volt-amps 0 to 3600 MVA

Maximum demanded power since last Demand reset

Power factor

Energy Measurements

Imported energy 0 to 9999999.9 Wh, kWh or MWh

Exported energy 0 to 9999999.9 Wh, kWh or MWh

Imported reactive energy 0 to 9999999.9 VAh, kVAh or MVAh

Exported reactive energy 0 to 9999999.9 VAh, kVAh or MVAh

Measured Inputs

Voltage inputs through 4-way fixed connector with 2.5mm² stranded wire capacity. 3-Phase 3- & 4-wire, and Single-phase 2-wire. Line frequency measured from L1 voltage or L3 voltage.

Three current inputs (six physical terminals) with 2.5mm² stranded wire capacity for connection of external CTs. Nominal rated input current 5A a.c. rms.

Range of Use

Voltage 5 to 120% of Range Maximum (below 5% of range maximum voltage, current indication may only be approximate)

Current 1 to 120% of nominal

Power factor 1 to 0, leading or lagging

Active power 1 to 144% of nominal, 3600 MW maximum

Apparent power 1 to 144% of nominal, 3600 MVA maximum

Power is only registered when voltage and current are within their respective range of use.

Power factor is only indicated when the measured VA is over 3% of range maximum.

Accuracy

Voltage 0.5% of range maximum

Current 0.5% of nominal

Neutral current 4% of nominal (calculated)

Frequency 0.2% of mid-frequency

Power factor 1% of unity (0.01)

Active power (W) ±1% of range maximum

Reactive power (VA) ±1% of range maximum

Apparent power (VA) ±1% of range maximum

Active energy (Wh) Class 1 IEC 62053-21 section 4.6

Reactive energy (VARh) ±1% of range maximum

Total harmonic distortion 1% up to 31st harmonic (above 30% THD the error in this reading may increase to 1.5% for the higher harmonics)

Temperature co-efficient, typ. Voltage and current = 0.013%/°C
Active energy = 0.018%/°C

Response time to step input 1s, typical, to >99% of final reading, at 50 Hz.

Error change due to variation of an influence quantity in the manner described in Section 6 of IEC 688:1992 2 × error allowed for the reference condition applied in the test. Error due to temperature variation as above.

Error in measurement when a measurand is within its measuring range, but outside its reference range 2 × error allowed at the end of the reference range adjacent to the section of the measuring range, where the measurand is currently operating / being tested.

Auxiliary Supply

Two-way fixed connector with 2.5mm² stranded wire capacity.
110 to 400V a.c. 50/60Hz ±10% or 120V to 350V d.c. ±20%.
Consumption < 10W.

Pulse Relay Output

The pulse relay output can be set to generate pulses to represent imported kWh, exported kWh, imported kVAh or exported kVAh.

Rate can be set to generate 1 pulse per:

0.001	= 1 Wh/VAh
0.01	= 10 Wh/VAh
0.1	= 100 Wh/VAh
1	= 1 kWh/kVAh
10	= 10 kWh/kVAh
100	= 100 kWh/kVAh
1k	= 1 MWh/MVAh
10k	= 10 MWh/MVAh

The rate cannot be set to a value that could result in more than 2 pulses per second.

Pulse width 200/100/60 ms.

Relay Rating 240V ac 50mA

RS485 Output for Modbus or JC N2 Protocol

For Modbus protocol, the following RS485 communication parameters can be configured from the Set-up menu:

Baud rate 2400, 4800, 9600, 19200, 38400

Parity none/odd/even

Stop bits 1 or 2

RS485 network address *nnn* – 3-digit number, 1 to 247

Modbus Word order Shows the word order (Hi/Lo) of the 8-bit bytes in the Modbus message format. This setting can only be changed from the Modbus port.

Note that with odd or even parity, Stop Bits are forced to one.

For JC N2 protocol, only the RS485 network address can be configured. The range of addresses is 1 to 255.

Reference Conditions of Influence Quantities

Influence Quantities are variables that affect measurement errors to a minor degree. Accuracy is verified under nominal value (within the specified tolerance) of these conditions.

Ambient temperature	23°C ±1°C
Input waveform	50 or 60Hz ±2%
Input waveform	Sinusoidal (distortion factor <0.005)
Auxiliary supply voltage	Nominal ±1%
Auxiliary supply frequency	Nominal ±1%
Auxiliary supply waveform (if AC)	Sinusoidal (distortion factor <0.05)
Magnetic field of external origin	Terrestrial flux

Environment

Operating temperature	-10°C to +55°C*
Storage temperature	-20°C to +70°C*
Relative humidity	0 to 90%, non-condensing
Altitude	Up to 2000m
Warm up time	1 minute
Vibration	10Hz to 50Hz, IEC 60068-2-6, 2g
Shock	30g in 3 planes

*Maximum operating and storage temperatures are in the context of typical daily and seasonal variation.

Mechanics

DIN rail dimensions	72 x 90 mm (WxH) per DIN 43880
Mounting	DIN rail (DIN 43880)
Sealing	IP20 (minimum)
Material	Self-extinguishing UL 94 V-0

Approval, Certification, and Standards Compliance

RoHS compliant. (Although this class of product is presently excluded from the RoHS regulations, the unit has been designed and manufactured in compliance with the RoHS regulations.)

EMC Emissions BS EN 61326, Class A (Industrial)

EMC Immunity BS EN 61326, Class A (Industrial)

Safety BS EN 61010-1:2001

While TE Connectivity (TE) has made every reasonable effort to ensure the accuracy of the information in this catalog, TE does not guarantee that it is error-free, nor does TE make any other representation, warranty or guarantee that the information is accurate, correct, reliable or current. TE reserves the right to make any adjustments to the information contained herein at any time without notice. TE expressly disclaims all implied warranties regarding the information contained herein, including, but not limited to, any implied warranties of merchantability or fitness for a particular purpose. The dimensions in this catalog are for reference purposes only and are subject to change without notice. Specifications are subject to change without notice. Consult TE for the latest dimensions and design specifications. TE connectivity (logo) and TE Connectivity are trademarks of the TE Connectivity Ltd. family of companies. Other logos, product and company names mentioned herein may be trademarks of their respective owners. Crompton is a trademark of Crompton Parkinson and is used by TE Connectivity under a licence.

Tyco Electronics (UK) Ltd
Freebournes Road,
Witham
Essex CM8 3AH
England
Tel: +44 (0) 1376 509509
Fax: +44 (0) 1376 509511
www.crompton-instruments.com
www.energy.te.com

Registered office:
Faraday Road, Dorcan
Swindon, SN3 5HH
Reg. no. 550 926

