

---

## Alarm Output Options for MAGNA & INT2 Series

**MRL1**                      2 alarm relays SPST

**MRL2**                      4 alarm relays

**MRL3**                      Dual Solid State alarms

**MRL4**                      Quad Solid State alarms

---



**LAUREL Electronics, Inc.**

3183-G Airway Ave, Costa Mesa, CA 92626, USA  
Tel +1 714-434-6131                      Fax +1 714-434-3766  
[www.laurels.com](http://www.laurels.com)                      [sales@laurels.com](mailto:sales@laurels.com)

# Warranty

We warrant our products against defects in materials or workmanship for a period of one year from the date of purchase.

In the event of a defect during the warranty period, the unit should be returned, freight (and all duties and taxes) prepaid by the Buyer to the authorised distributor from where the unit was purchased.

The Distributor, at its option, will repair or replace the defective unit. The unit will be returned to the Buyer with freight charges prepaid by the distributor.

## **LIMITATION OF WARRANTY**

The foregoing warranty shall not apply to defects resulting from:

1. Improper or inadequate maintenance by the buyer.
2. Unauthorised modification or misuse.
3. Operation outside the environmental specification of the product.
4. Mishandling or abuse.

The warranty set forth above is exclusive and no other warranty, whether written or oral is expressed or implied. We specifically disclaim the implied warranties of merchantability and fitness for a particular purpose.

## **EXCLUSIVE REMEDIES**

The remedies provided herein are the buyer's sole and exclusive remedies.

In no event shall we be liable for direct, indirect, incidental or consequential damages (including loss of profits) whether based on contract, tort or any other legal theory.

# Contents

Connections	See main meter manual
Installation into a meter	See main meter manual
General Description	4
Physical Types of Alarms	5
Installation Hints for best performance	6
Trouble-shooting and fault finding	7
Alarm option prompts and their meanings	8
Alarm board configuration	9
Basic High Alarm with Hysteresis	10-11
Basic Low Alarm with Hysteresis	12-13
High alarm with manual In-Flight correction	14-15
Low alarm with manual In-Flight correction	16-17
High alarm with automatic In-Flight correction	18-19
Low alarm with automatic In-Flight correction	20-21
In-Band alarm	22-23
Out-Band alarm	24-25
Pump control low alarm	26-27
Pump control high alarm	28-29
Easy / Advanced menu selection	30
Specifications	31
Record of Revisions	32
Warranty	2

\* Need manuals urgently? Download manuals from our website!

## General Description

This manual covers the alarm output option only. Please refer to the main display's operating manual for full specifications, installation methods, safety notices etc. You can download manuals from our website.

The alarm output option lets you create up to 4 relay or 2 solid state switch outputs, which will operate when certain conditions occur, and you can program this using the front panel buttons.

The outputs may be used to control a process in a closed loop system, for example, by opening or closing valves, operating heaters, adding ingredients etc., or can simply feed power to, or remove power from external devices such as warning sounders, beacons etc.

The outputs are volt-free. That means you can wire whichever signals you wish to them, AC or DC, provided the voltage and current lies within the relays' rated limits.

There are several alarm actions available as standard, which include....

1. **High alarm** with adjustable hysteresis, and automatic or manual in-flight correction.
2. **Low alarm** with adjustable hysteresis, and automatic or manual in-flight correction.
3. **In-band alarm**, where you set a high and low limit for each relay.
4. **Out-of-band alarm**, where you set a high and low limit for each relay.
5. **Pump** or reservoir control function.
6. **OFF** - disables all alarm relay action.

Independent timers let you set a delay to activate and delay to reset time on each relay. You can also set the relays to operate with variable duty cycles.

The relays can be set to be normally energised, to de-energise on trip (failsafe)  
The relays can be set to be normally de-energised, to energise on trip (non-failsafe)

Each relay is independent, so you can have one relay performing a different function to the others, with different setpoints.

Each relay has an LED on the front panel of the display, so that you can see the status of each alarm channel.

These LEDs and all the standard comparison functions are present in the display even if you do not have the alarm options fitted.

This means you can produce a simple alarm annunciator with the basic display - there is no need to buy the alarm option if you only want to visualise alarm conditions and do not need switched alarm outputs.

# Physical Types of Alarms

You can choose from 4 different physical versions of the alarm boards:-

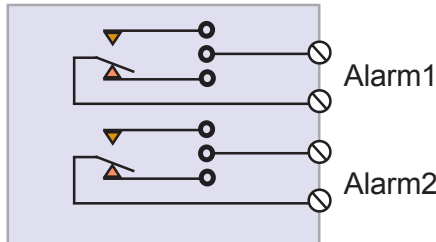

## Alarm Option MRL1

2 relay alarm board, with 2 x single-pole changeover relays. You can select whether the normally open or normally closed contacts are available at the connector.

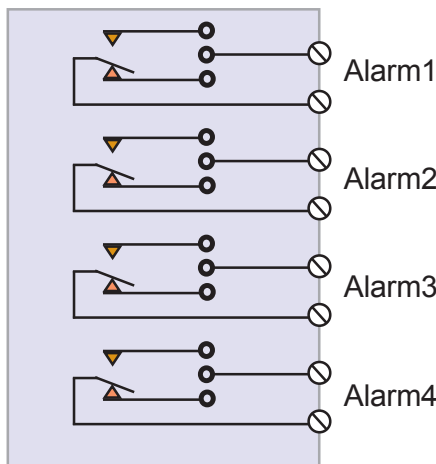

## Alarm Option MRL2

4 relay alarm board, with 4 x single-pole changeover relays. You can select whether the normally open or normally closed contacts are available at the connector.

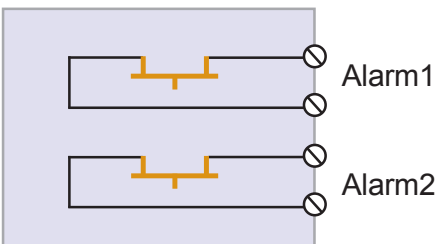

## Alarm Option MRL3

Dual Solid State alarm. Because this is non-mechanical, there is no mechanical wear, so this version is often specified in applications having high repetition rate relay action, where a normal mechanical relay would wear out in a short time.

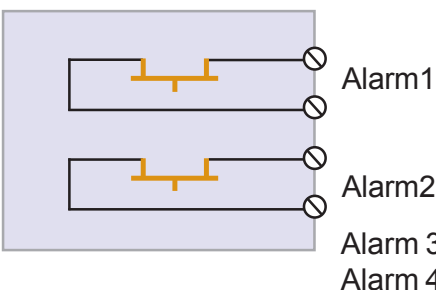

## Alarm Option MRL4

Quad Solid State alarm. Same as MRL3, but with four solid state relays

# Installation Hints for Best Performance

This section offers several suggestions which will help you get the best performance from your alarm relay output board.

1. Route your relay cabling away from any signal cabling. This is because when the relay operates and switches your load, large electrical noise spikes can be created, and these can interfere with low-level signals. Ideally the relay cabling will be in a separate cable tray or conduit, along with other power cabling.
2. You can leave the alarm section of the display unlocked, but lock the main setup system of the display, if you wish. Or you can lock everything out, to prevent any adjustments. Simply switch the Alarm lockout switch on or off, and the Calibration lockout switch on or off, in a combination which best suits your requirements.
3. If you are switching an inductive load, such as a contactor or solenoid, you should use a varistor or flywheel diode to limit the electrical noise spike which will occur when your relay contacts open. This noise spike is caused by the rapidly collapsing magnetic field in the contactor or solenoid, and can create thousands of volts of noise.

Contact the manufacturer of the inductive load, who should be able to guide you regarding suitable varistor or flywheel diode. Most contactor manufacturers have standard varistor and diode accessories.

The varistor or flywheel diode should be mounted at the inductive-load end of the cable, not at the display end. See below for guidance.

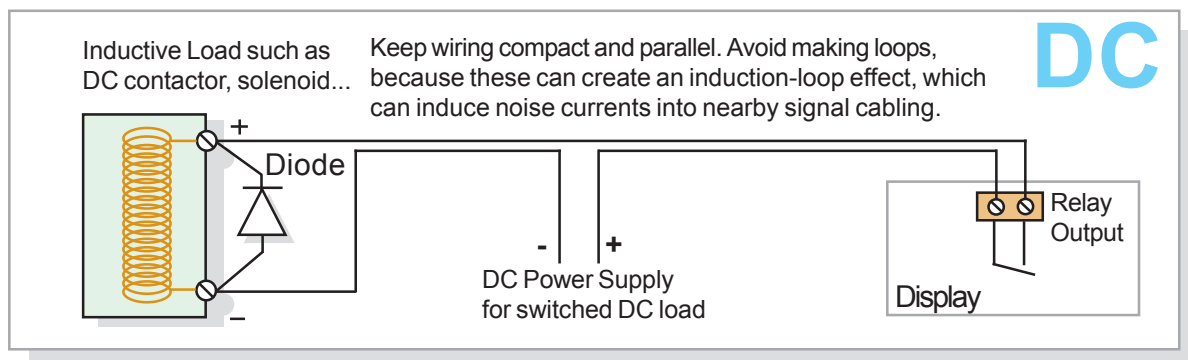
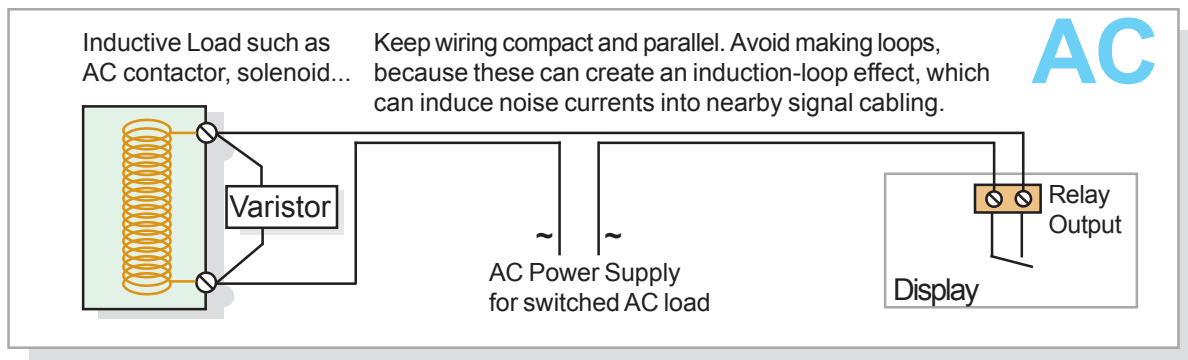

# Troubleshooting and Faultfinding

**Q.** I am switching AC power voltage through your relays, but I notice that when the relay contacts should be open, I am still measuring a high AC voltage. What is wrong?

**A.** This is probably because you are using a high impedance digital voltmeter, so there is no load current being drawn through the relay. Our relays include a small capacitor and resistor across the contacts to reduce contact arcing, the benefit is greatly increased contact life. If you measure the open contact resistance, using a DC resistance meter, you will measure open circuit, or infinity.

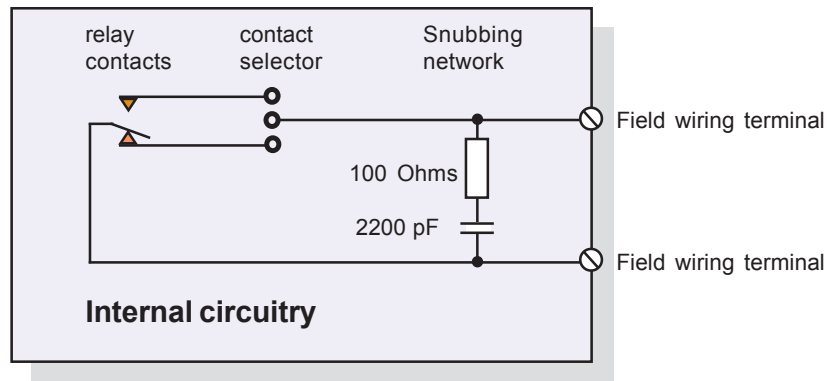

But because you are switching an AC signal, the capacitor is acting as a charge coupler, and your voltmeter is detecting the coupled AC voltage. If you were to use a traditional, lower impedance moving pointer meter, such as an AVO, you would probably not see this effect. The impedance of the capacitor is very high, around 1 500 000 Ohms with 50Hz AC or 1 200 000 Ohms with 60Hz AC.

In rare cases, if you want to remove the capacitor because its effect is influencing your system, you can do so. C5 is associated with Alarm 1, C6 with Alarm 2, C7 with Alarm 3 and C8 with Alarm 4. They are located on the printed circuit board immediately in front of the alarm connectors.

**Q.** I have set my -AL4 relays to energise on trip, but the contacts open when the alarm LED comes on. I expected the contacts to close. Why is this happening?

**A.** There is a push on contact-selector switch near each relay, which lets you chose the normally open or normally closed contact of the relay. Move this switch and you will get the function you want.

Our default setting is for the contacts to open on alarm, and for the relay to de-energise on alarm, because this gives failsafe operation.

See the page in this manual which describes configuration of the alarm board

# Alarm Option Prompts and Their Meanings

<b>AL CFG</b>	=	Alarm Configuration. Confirms that you can configure the alarms.
<b>FL.HI</b>	=	In Flight manually compensated HI alarm. Relay will trip if display value is above setpoint.
<b>FL.HI.A</b>	=	In Flight automatically compensated HI alarm. Relay will trip if display value is above setpoint.
<b>FL.Lo</b>	=	In Flight manually compensated LO alarm. Relay will trip if display value is below setpoint.
<b>FL.Lo.A</b>	=	In Flight automatically compensated LO alarm. Relay will trip if display value is below setpoint.
<b>FL.Amt</b>	=	In-flight amount.
<b>Gross</b>	=	Setpoint will be compared to Gross value.
<b>HI</b>	=	High Alarm. Relay will trip if display value is above setpoint.
<b>HYS</b>	=	Hysteresis. In simple HI or LO alarm mode, the difference between alarm trip and reset values.
<b>In.bnd</b>	=	In-band alarm. Relay will trip if display value is within two limits.
<b>Lo</b>	=	Low Alarm. Relay will trip if display value is below setpoint.
<b>Net</b>	=	Setpoint will be compared to Net value.
<b>OFF</b>	=	No alarm mode has yet been set, so this alarm relay will be inactive.
<b>OFF.tr</b>	=	Off-delay before the relay will reset following a return to healthy condition.
<b>On.tr</b>	=	On-delay before the relay will activate following a trip condition.
<b>Out.bnd</b>	=	Out-band alarm. Relay will trip if display value is outside two limits.
<b>PC.HI</b>	=	Pump control, HI alarm.
<b>PC.Lo</b>	=	Pump control, LO alarm.
<b>rLY dE</b>	=	Relay will De-Energize on alarm. (Failsafe)
<b>rLY En</b>	=	Relay will Energize on alarm.
<b>Set.Pnt</b>	=	Setpoint. The main alarm comparison point.
<b>t.out</b>	=	Period during which alarm relay will remain active during a trip condition.



# Alarm Output Board Configuring

Your alarm board will either have 0, 2 or 4 mechanical alarm relays, or 2 solid state relays. It may have no alarm relays if it is being used simply to host an analog or serial output board.

The only function you may need to physically set on this board is the relay contact status. Each relay can be set to provide closed or open contacts when it is de-energized.

Our default is to provide contacts which open when the relay de-energizes - this is the failsafe mode.

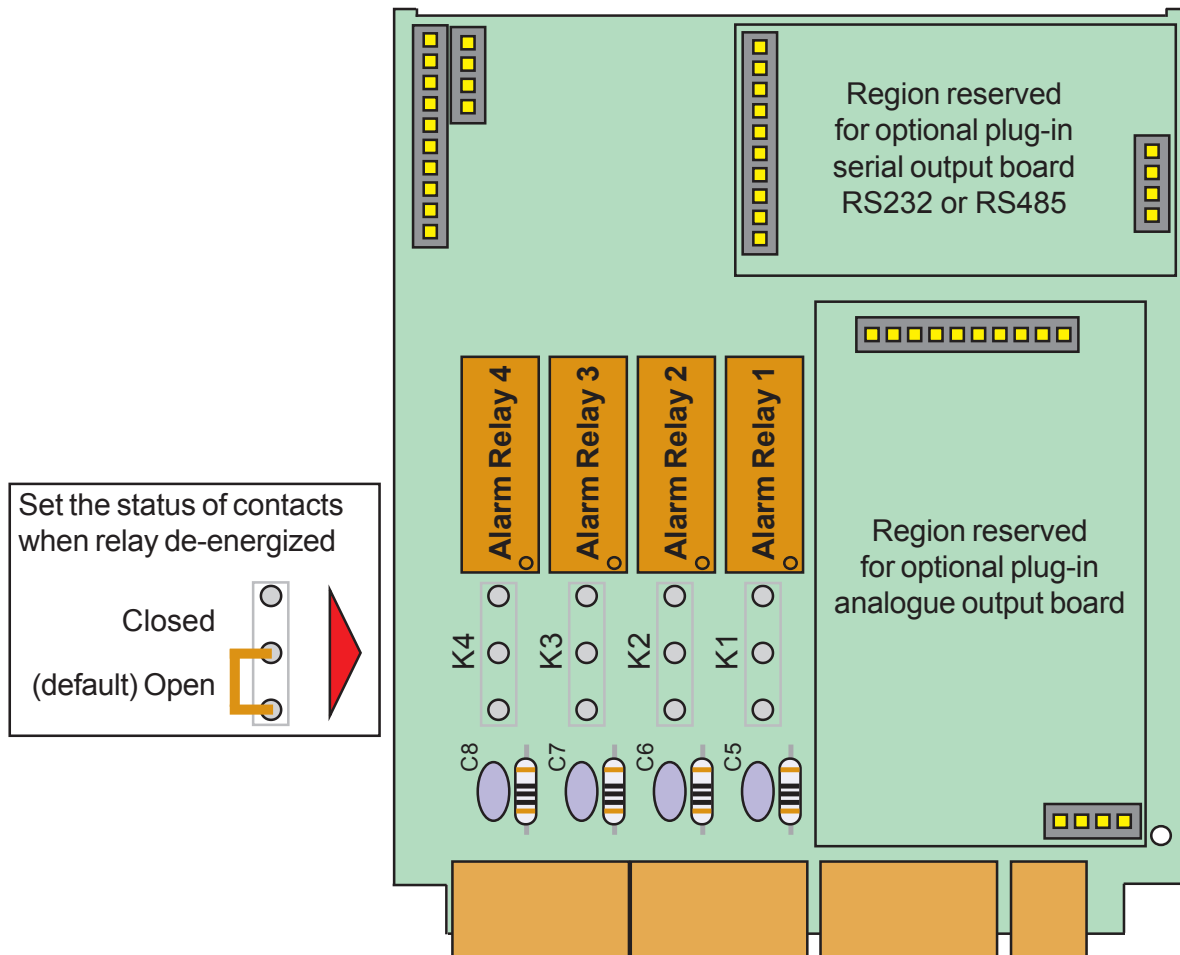

The solid state versions do not have any on-board configuration settings.

# Basic High Alarm with Hysteresis

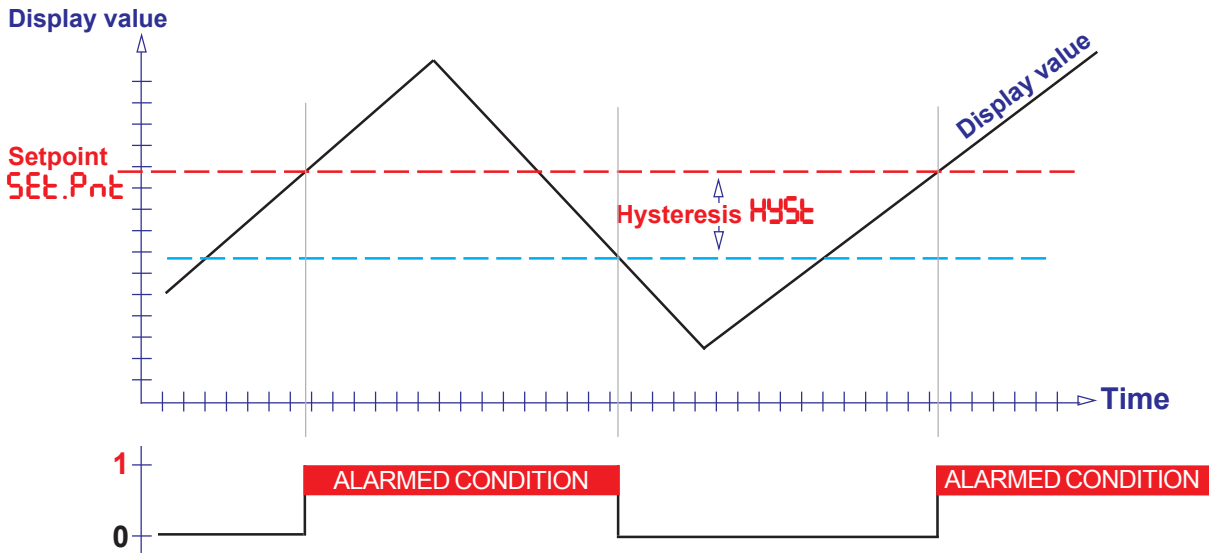

The Setpoint can be placed anywhere you like, in the range **-999999** to **+999999** and will include a decimal point in the appropriate position if you have set your display range to have a decimal point.

- Setpoint                **SEt.Pnt** = The point at which you want the alarm to occur
- Alarm configuration    **ALCF9** , then use the UP button to choose **H** = High Alarm mode then press OK to accept
- Net or Gross            **NET** = alarm compared to nett value, or **Gross** = alarm compared to gross value. Use UP button to toggle between these options and press OK to accept.
- Hysteresis              **HYSL** = the amount by which the reading must drop below the alarm point before the relay will reset. Can be set to 999999 if you want the alarm to latch.
- Relay state              **RLY dE** = Relay de-energises on trip (failsafe)  
                               **RLY En** = Relay energises on trip

## The following settings are available in the Advanced Menu only.

- Relay timing            **On. tr** = Time delay in seconds from the start of an alarm condition, to the relay changing state, provided the alarm condition remains present during that period.
- t.Out** = Time in seconds that the alarm relay will remain active, provided the alarm condition remains present during that period.
- OFF. tr** = Time delay in seconds from an alarm condition ending, to the relay changing state. Will clear if alarm condition returns before the delay has completed

# How to Set a Basic High Alarm with Hysteresis

1

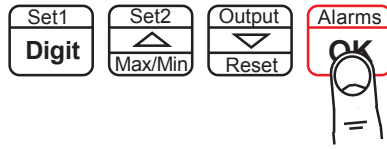

Lockout Switch must be OFF



Circuit board ON

Press briefly to view each existing setpoint, if one has already been set. The LEDs to the right of the display will illuminate to show you which alarm channel you are viewing.



The display will show (in dim numerals) the existing setpoint level for that alarm, or it will show **OFF** if that alarm has not yet been given a mode.

If the setpoint was displayed, and you want to change it, press the Alarm button for a further 3 seconds, and you will see the prompt **SetPnt**. You can now change the setpoint value. Use the DIGIT button to select each digit in turn, and the UP or DOWN button to change the value of each digit. When you have edited the setpoint and want to save it, press OK.

If you want to change the Alarm Configuration, press the Alarm button and wait until the display shows **ALCF9**. Other prompts such as **SetPnt** may appear first, but do not release the alarm button until you see **ALCF9**. This will take between 3 and 6 seconds to appear.

You will see the existing mode, which may say **OFF**, **Lo**, or **H**, if you are in Easy Menu mode or **OFF**, **Lo**, **H**, **FLH**, **FLLo**, **FLH/A**, **FLLo/A**, **In.bnd**, **Out.bnd**, **PC.H**, or **PC.Lo** if you are in Advanced Menu mode.

Use the UP or Down Buttons to scroll through the available choices and press OK when you see **H**.

2

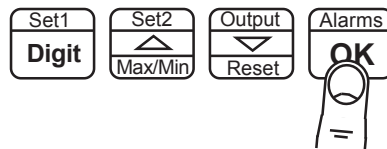

Press to accept



Now simply follow the prompts you will see, according to the list opposite, make your choices and accept with the OK button.

# Basic Low Alarm with Hysteresis

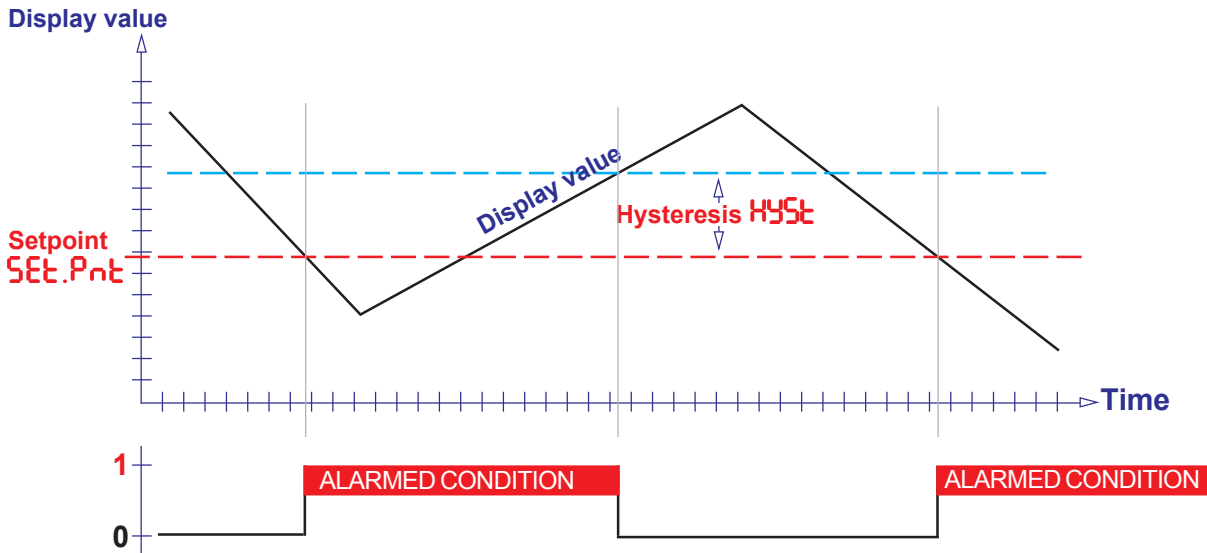

The Setpoint can be placed anywhere you like, in the range **-999999** to **+999999** and will include a decimal point in the appropriate position if you have set your display range to have a decimal point.

- Setpoint                    **SEt.Pnt** = The point at which you want the alarm to occur
- Alarm configuration      **ALCF9** , then use the UP button to choose **Lo** = Low Alarm mode then press OK to accept
- Net or Gross              **NET** = alarm compared to nett value, or **GROSS** = alarm compared to gross value. Use UP button to toggle between these options and press OK to accept.
- Hysteresis                 **HYSL** = the amount by which the reading must rise above the alarm point before the relay will reset. Can be set to 999999 if you want the alarm to latch.
- Relay state                **RLY dE** = Relay de-energises on trip (failsafe)  
**RLY En** = Relay energises on trip

## The following settings are available in the Advanced Menu only.

- Relay timing              **On. tr** = Time delay in seconds from the start of an alarm condition, to the relay changing state, provided the alarm condition remains present during that period.
- t. Out** = Time in seconds that the alarm relay will remain active, provided the alarm condition remains present during that period.
- OFF. tr** = Time delay in seconds from an alarm condition ending, to the relay changing state. Will clear if alarm condition returns before the delay has completed.

# How to Set a Basic Low Alarm with Hysteresis

1

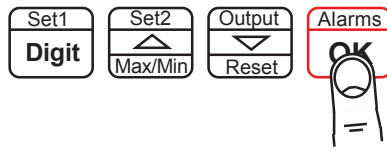

Lockout Switch must be OFF



Circuit board ON

Press briefly to view each existing setpoint, if one has already been set. The LEDs to the right of the display will illuminate to show you which alarm channel you are viewing.



The display will show (in dim numerals) the existing setpoint level for that alarm, or it will show **OFF** if that alarm has not yet been given a mode.

If the setpoint was displayed, and you want to change it, press the Alarm button for a further 3 seconds, and you will see the prompt **SEtPt**. You can now change the setpoint value. Use the DIGIT button to select each digit in turn, and the UP or DOWN button to change the value of each digit. When you have edited the setpoint and want to save it, press OK.

If you want to change the Alarm Configuration, press the Alarm button and wait until the display shows **ALCF9**. Other prompts such as **SEtPt** may appear first, but do not release the alarm button until you see **ALCF9**. This will take between 3 and 6 seconds to appear.

You will see the existing mode, which may say **OFF**, **Lo**, or **H**, if you are in Easy Menu mode or **OFF**, **Lo**, **H**, **FLH**, **FLLo**, **FLH.A**, **FLLo.A**, **In.bnd**, **Out.bnd**, **PC.H**, or **PC.Lo** if you are in Advanced Menu mode.

Use the UP or Down Buttons to scroll through the available choices and press OK when you see **Lo**

2

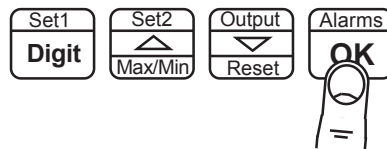

Press to accept



Now simply follow the prompts you will see, according to the list opposite, make your choices and accept with the OK button.

# High Alarm with Manual In-Flight Correction

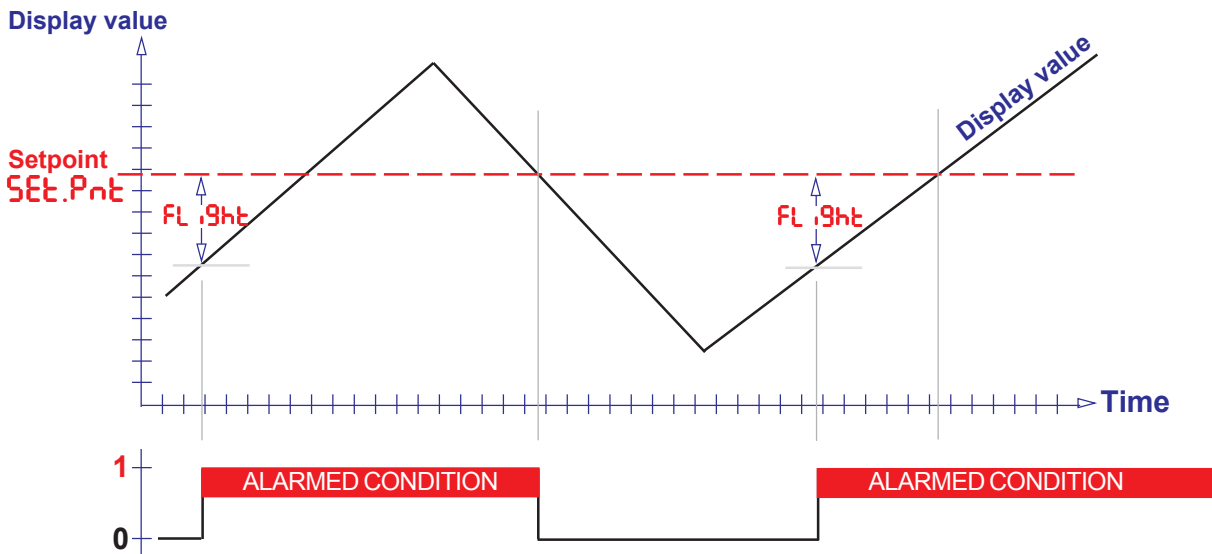

The Setpoint can be placed anywhere you like, in the range **-999999** to **+999999** and will include a decimal point in the appropriate position if you have set your display range to have a decimal point.

- Setpoint                    **SEt.Pnt** = The point at which you want the alarm to occur
- Alarm configuration    **ALCF9** , then use the UP button to choose **FL.HI** = High Alarm mode with manual Inflight correction then press OK to accept
- Net or Gross            **Net** = alarm compared to nett value, or **Gross** = alarm compared to gross value. Use UP button to toggle between these options and press OK to accept.
- In Flight correction    **FLght** = the amount by which the alarm will pre-trip, to ensure that when the fill cycle is complete, the target weight has been achieved. This is a manually set value and remains fixed, so you may need to edit it if your material flow characteristics change. Or, you may find the automatic in-flight mode may be better for you.
- Relay state              **rLY dE** = Relay de-energises on trip (failsafe)  
                               **rLY En** = Relay energises on trip

# How to Set a High Alarm with Manual In-Flight

1

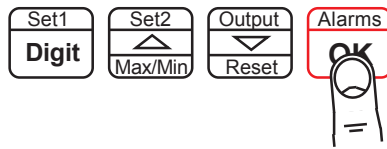

Lockout Switch must be OFF



Circuit board ON

Press briefly to view each existing setpoint, if one has already been set. The LEDs to the right of the display will illuminate to show you which alarm channel you are viewing.



The display will show (in dim numerals) the existing setpoint level for that alarm, or it will show **OFF** if that alarm has not yet been given a mode.

If the setpoint was displayed, and you want to change it, press the Alarm button for a further 3 seconds, and you will see the prompt **SEtPnt**. You can now change the setpoint value. Use the DIGIT button to select each digit in turn, and the UP or DOWN button to change the value of each digit. When you have edited the setpoint and want to save it, press OK.

If you want to change the Alarm Configuration, press the Alarm button and wait until the display shows **AL CF9**. Other prompts such as **SEtPnt** may appear first, but do not release the alarm button until you see **AL CF9**. This will take between 3 and 6 seconds to appear.

You will see the existing mode, which may say **OFF**, **Lo**, or **H**, if you are in Easy Menu mode or **OFF**, **Lo**, **H**, **FL.H**, **FL.Lo**, **FL.H.A**, **FL.Lo.A**, **In.bnd**, **Out.bnd**, **PC.H**, or **PC.Lo** if you are in Advanced Menu mode.

Use the UP or Down Buttons to scroll through the available choices and press OK when you see **FL.H**.

2

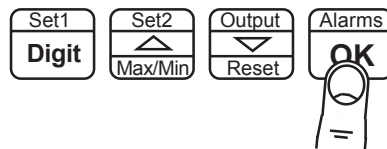

Press to accept



Now simply follow the prompts you will see, according to the list opposite, make your choices and accept with the OK button.

# Low Alarm with Manual In-Flight Correction

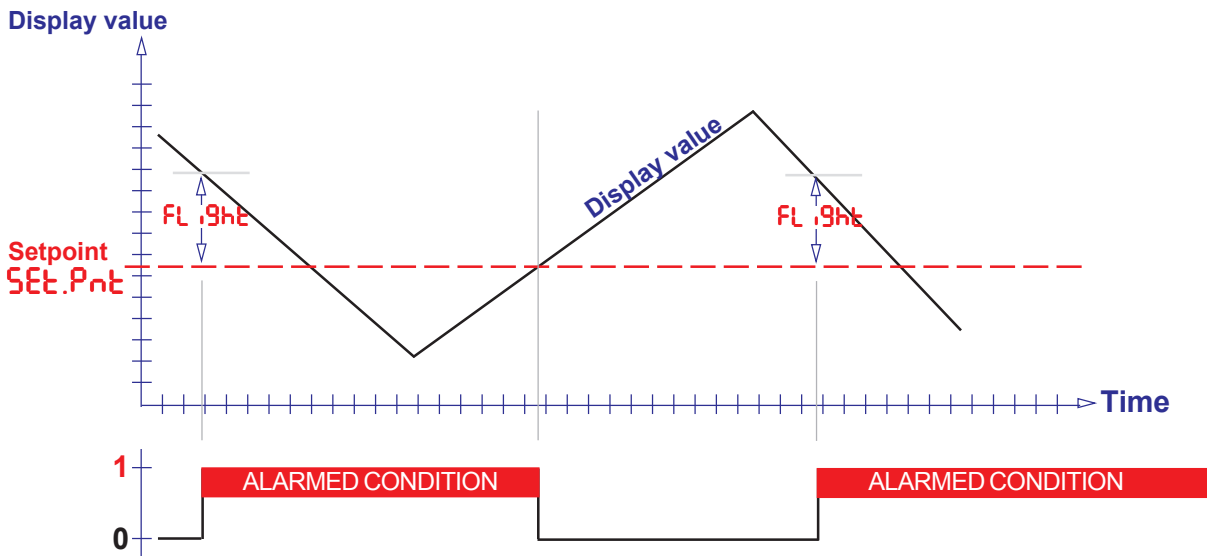

The Setpoint can be placed anywhere you like, in the range **-999999** to **+999999** and will include a decimal point in the appropriate position if you have set your display range to have a decimal point.

- Setpoint                    **SEt.Pnt** = The point at which you want the alarm to occur
- Alarm configuration    **AL CF9** , then use the UP button to choose **FL.Lo** = Low Alarm mode with manual Inflight correction then press OK to accept
- Net or Gross            **Net** = alarm compared to nett value, or **Gross** = alarm compared to gross value. Use UP button to toggle between these options and press OK to accept.
- In Flight correction    **FL .9ht** = the amount by which the alarm will pre-trip, to ensure that when the empty cycle is complete, the target weight has been achieved. This is a manually set value and remains fixed, so you may need to edit it if your material flow characteristics change. Or, you may find the automatic in-flight mode may be better for you.
- Relay state              **rLY dE** = Relay de-energises on trip (failsafe)  
                               **rLY En** = Relay energises on trip



# How to Set a Low Alarm with Manual In-Flight

1

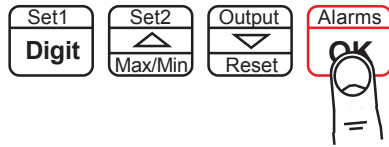

Lockout Switch must be OFF



Circuit board ON

Press briefly to view each existing setpoint, if one has already been set. The LEDs to the right of the display will illuminate to show you which alarm channel you are viewing.



The display will show (in dim numerals) the existing setpoint level for that alarm, or it will show **OFF** if that alarm has not yet been given a mode.

If the setpoint was displayed, and you want to change it, press the Alarm button for a further 3 seconds, and you will see the prompt **SEtPnt**. You can now change the setpoint value. Use the DIGIT button to select each digit in turn, and the UP or DOWN button to change the value of each digit. When you have edited the setpoint and want to save it, press OK.

If you want to change the Alarm Configuration, press the Alarm button and wait until the display shows **AL CF9**. Other prompts such as **SEtPnt** may appear first, but do not release the alarm button until you see **AL CF9**. This will take between 3 and 6 seconds to appear.

You will see the existing mode, which may say **OFF**, **Lo**, or **H**, if you are in Easy Menu mode or **OFF**, **Lo**, **H**, **FL.H**, **FL.Lo**, **FL.H.A**, **FL.Lo.A**, **In.bnd**, **Out.bnd**, **PC.H**, or **PC.Lo** if you are in Advanced Menu mode.

Use the UP or Down Buttons to scroll through the available choices and press OK when you see **FL.Lo**

2

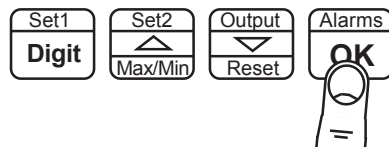

Press to accept



Now simply follow the prompts you will see, according to the list opposite, make your choices and accept with the OK button.

# High Alarm with Auto In-Flight Correction

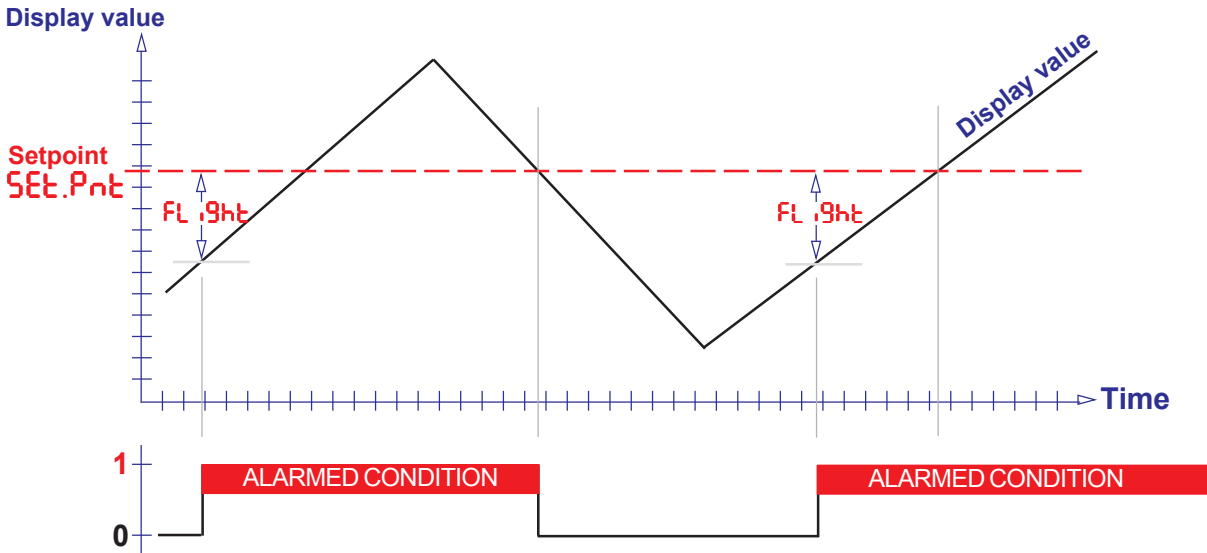

The Setpoint can be placed anywhere you like, in the range **-999999** to **+999999** and will include a decimal point in the appropriate position if you have set your display range to have a decimal point.

- Setpoint                    **SEt.Pnt** = The point at which you want the alarm to occur
- Alarm configuration    **ALCF9** , then use the UP button to choose **FL.H.A** = High Alarm mode with automatic Inflight correction then press OK to accept
- Net or Gross            **NET** = alarm compared to nett value, or **GROSS** = alarm compared to gross value. Use UP button to toggle between these options and press OK to accept.
- In Flight correction    **FL .9ht** = the amount by which the alarm will pre-trip, to ensure that when the fill cycle is complete, the target weight has been achieved.  
  
 This is initially a manually set value, which you estimate as closely as you can, to be the expected in-flight error. Then, after the 1st fill, the meter will compare the result to desired value and will automatically adjust the **FL .9ht** figure to try to achieve better accuracy for the next fill operation.  
  
 This adaptation will occur for every fill cycle, so gradual changes in material flow characteristics, feed rates etc will be tracked automatically.
- Relay state              **RLY dE** = Relay de-energises on trip (failsafe)  
                               **RLY En** = Relay energises on trip

# How to Set a High Alarm with Auto In-Flight

1

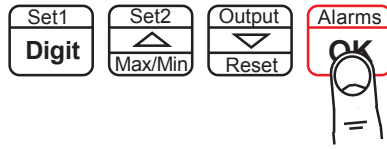

Lockout Switch must be OFF



Circuit board ON

Press briefly to view each existing setpoint, if one has already been set. The LEDs to the right of the display will illuminate to show you which alarm channel you are viewing.



The display will show (in dim numerals) the existing setpoint level for that alarm, or it will show **OFF** if that alarm has not yet been given a mode.

If the setpoint was displayed, and you want to change it, press the Alarm button for a further 3 seconds, and you will see the prompt **SetPt**. You can now change the setpoint value. Use the DIGIT button to select each digit in turn, and the UP or DOWN button to change the value of each digit. When you have edited the setpoint and want to save it, press OK.

If you want to change the Alarm Configuration, press the Alarm button and wait until the display shows **AL CF9**. Other prompts such as **SetPt** may appear first, but do not release the alarm button until you see **AL CF9**. This will take between 3 and 6 seconds to appear.

You will see the existing mode, which may say **OFF**, **Lo**, or **H**, if you are in Easy Menu mode or **OFF**, **Lo**, **H**, **FLH**, **FLLo**, **FLH.A**, **FLLo.A**, **In.bnd**, **Out.bnd**, **PC.H**, or **PC.Lo** if you are in Advanced Menu mode.

Use the UP or Down Buttons to scroll through the available choices and press OK when you see **FLH.A**

2

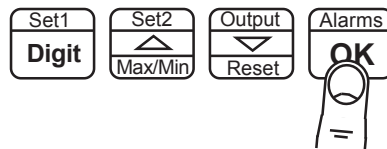

Press to accept



Now simply follow the prompts you will see, according to the list opposite, make your choices and accept with the OK button.

# Low Alarm with Auto In-Flight Correction

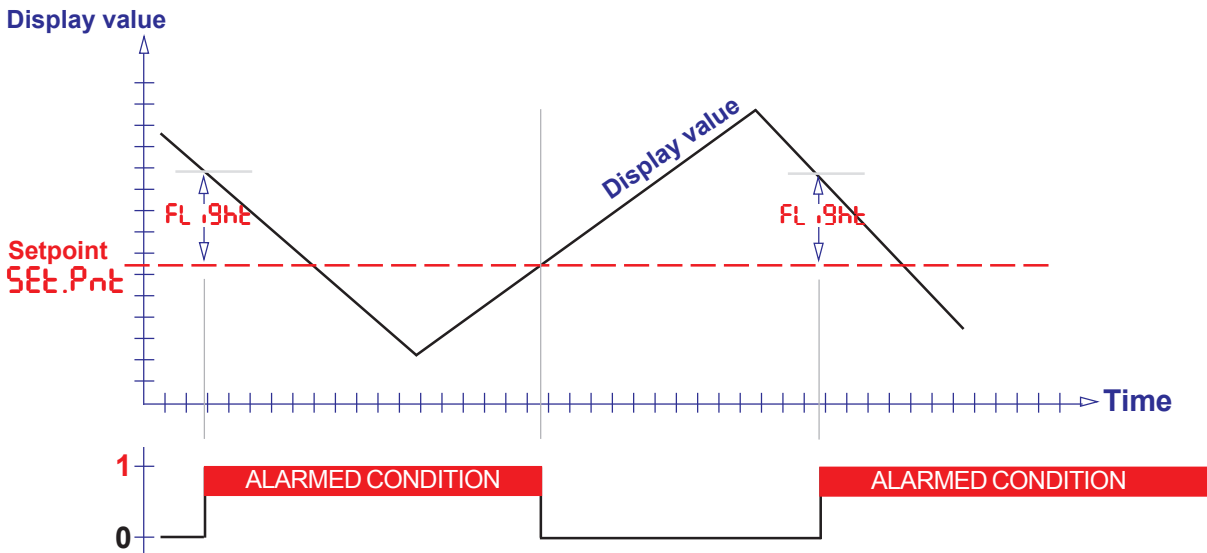

The Setpoint can be placed anywhere you like, in the range **-999999** to **+999999** and will include a decimal point in the appropriate position if you have set your display range to have a decimal point.

- Setpoint                    **Set.Pnt** = The point at which you want the alarm to occur
- Alarm configuration    **ALCF9** , then use the UP button to choose **FLLoA** = Low Alarm mode with automatic Inflight correction then press OK to accept
- Net or Gross            **Net** = alarm compared to nett value, or **Gross** = alarm compared to gross value. Use UP button to toggle between these options and press OK to accept.
- In Flight correction    **FLght** = the amount by which the alarm will pre-trip, to ensure that when the empty cycle is complete, the target weight has been achieved.

This is initially a manually set value, which you estimate as closely as you can, to be the expected in-flight error. Then, after the 1st empty, the meter will compare the result to desired value and will automatically adjust the **FLght** figure to try to achieve better accuracy for the next emptying operation.

This adaptation will occur for every empty cycle, so gradual changes in material flow characteristics, feed rates etc will be tracked automatically.

- Relay state              **rLY dE** = Relay de-energises on trip (failsafe)
- rLY En** = Relay energises on trip

# How to Set a Low Alarm with Auto In-Flight

1

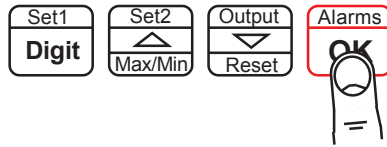

Lockout Switch must be OFF



Circuit board ON

Press briefly to view each existing setpoint, if one has already been set. The LEDs to the right of the display will illuminate to show you which alarm channel you are viewing.



The display will show (in dim numerals) the existing setpoint level for that alarm, or it will show **OFF** if that alarm has not yet been given a mode.

If the setpoint was displayed, and you want to change it, press the Alarm button for a further 3 seconds, and you will see the prompt **SEtPt**. You can now change the setpoint value. Use the DIGIT button to select each digit in turn, and the UP or DOWN button to change the value of each digit. When you have edited the setpoint and want to save it, press OK.

If you want to change the Alarm Configuration, press the Alarm button and wait until the display shows **AL CF9**. Other prompts such as **SEtPt** may appear first, but do not release the alarm button until you see **AL CF9**. This will take between 3 and 6 seconds to appear.

You will see the existing mode, which may say **OFF**, **Lo**, or **H**, if you are in Easy Menu mode or **OFF**, **Lo**, **H**, **FLH**, **FLLo**, **FLH A**, **FLLo A**, **In.bnd**, **Out.bnd**, **PC.H**, or **PC.Lo** if you are in Advanced Menu mode.

Use the UP or Down Buttons to scroll through the available choices and press OK when you see **FLLo A**

2

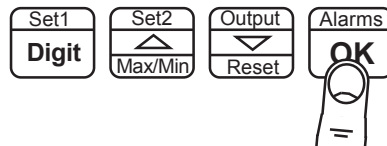

Press to accept



Now simply follow the prompts you will see, according to the list opposite, make your choices and accept with the OK button.

# In-Band Alarm

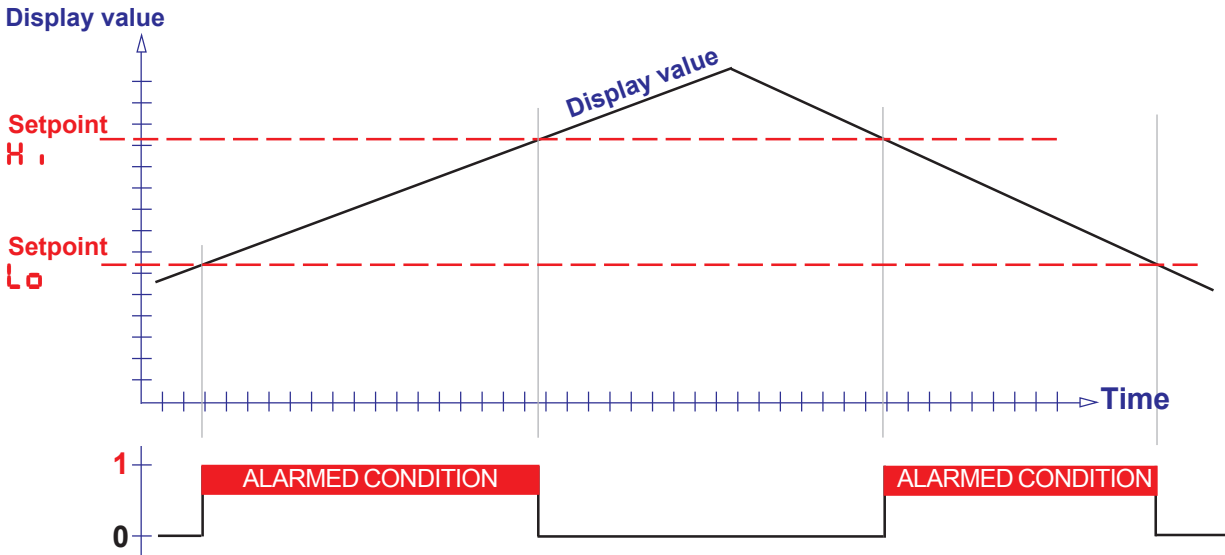

The Setpoint can be placed anywhere you like, in the range **-999999** to **+999999** and will include a decimal point in the appropriate position if you have set your display range to have a decimal point.

- Setpoint                    **SEt.Pnt** = The upper point of the band.
- Alarm configuration    **ALCF9** , then use the UP button to choose **in.band** = In-Band alarm then press OK to accept
- Net or Gross            **NET** = alarm compared to nett value, or **Gross** = alarm compared to gross value. Use UP button to toggle between these options and press OK to accept.
- Hi Limit                    **Hi** = the upper point of the band
- Lo Limit                    **Lo** = the lower part of the band
- Relay state                **RLY dE** = Relay de-energises on trip (failsafe)  
**RLY En** = Relay energises on trip
- Relay timing              **On. tr** = Time delay in seconds from the start of an alarm condition, to the relay changing state, provided the alarm condition remains present during that period.  
  
**t.Out** = Time in seconds that the alarm relay will remain active, provided the alarm condition remains present during that period.  
  
**OFF. tr** = Time delay in seconds from an alarm condition ending, to the relay changing state. Will clear if alarm condition returns before the delay has completed.

# How to Set an In-Band Alarm

1

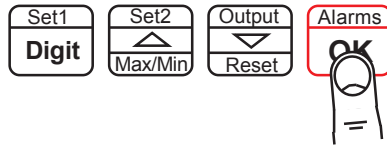

Lockout Switch must be OFF



Circuit board ON

Press briefly to view each existing setpoint, if one has already been set. The LEDs to the right of the display will illuminate to show you which alarm channel you are viewing.



The display will show (in dim numerals) the existing setpoint level for that alarm, or it will show **OFF** if that alarm has not yet been given a mode.

If the setpoint was displayed, and you want to change it, press the Alarm button for a further 3 seconds, and you will see the prompt **SEtPnt**. You can now change the upper setpoint value. Use the DIGIT button to select each digit in turn, and the UP or DOWN button to change the value of each digit. When you have edited the setpoint and want to save it, press OK.

If you want to change the Alarm Configuration, press the Alarm button and wait until the display shows **AL CF9**. Other prompts such as **SEtPnt** may appear first, but do not release the alarm button until you see **AL CF9**. This will take between 3 and 6 seconds to appear.

You will see the existing mode, which may say **OFF**, **Lo**, or **H**, if you are in Easy Menu mode or **OFF**, **Lo**, **H**, **FLH**, **FLLo**, **FLH.A**, **FLLo.A**, **In.bnd**, **Out.bnd**, **PC.H**, or **PC.Lo** if you are in Advanced Menu mode.

Use the UP or Down Buttons to scroll through the available choices and press OK when you see **In.bnd**

2

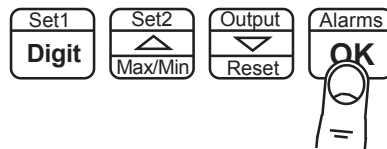

Press to accept



Now simply follow the prompts you will see, according to the list opposite, make your choices and accept with the OK button.

# Out-Band Alarm

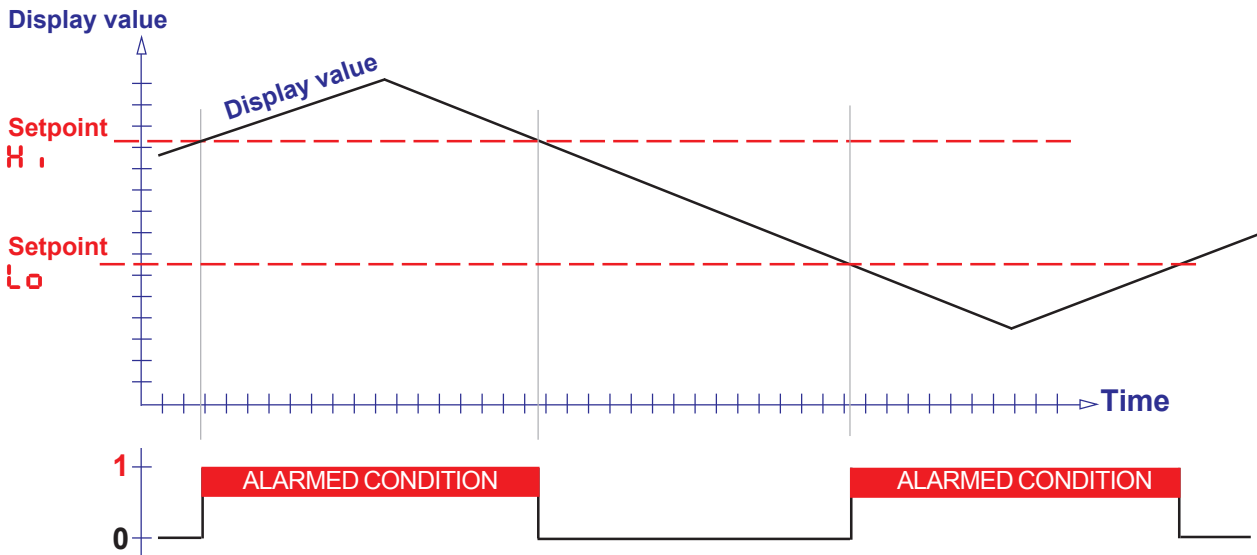

The Setpoints can be placed anywhere you like, in the range **-999999** to **+999999** and will include a decimal point in the appropriate position if you have set your display range to have a decimal point.

- Setpoint                    **SEt.Pnt** = The upper point of the band.
- Alarm configuration    **ALCF9** , then use the UP button to choose **Out.bnd** = Out-Band alarm then press OK to accept
- Net or Gross            **Net** = alarm compared to nett value, or **Gross** = alarm compared to gross value. Use UP button to toggle between these options and press OK to accept.
- Hi Limit                    **Hi** = the upper point of the band
- Lo Limit                    **Lo** = the lower part of the band
- Relay state                **RLY dE** = Relay de-energises on trip (failsafe)  
**RLY En** = Relay energises on trip
- Relay timing              **On. tr** = Time delay in seconds from the start of an alarm condition, to the relay changing state, provided the alarm condition remains present during that period.  
**t. Out** = Time in seconds that the alarm relay will remain active, provided the alarm condition remains present during that period.  
**OFF. tr** = Time delay in seconds from an alarm condition ending, to the relay changing state. Will clear if alarm condition returns before the delay has completed.



# How to Set an Out-Band Alarm

1

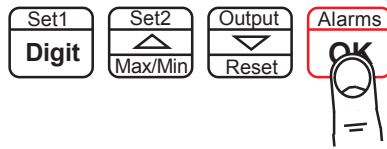

Lockout Switch must be OFF



Circuit board ON

Press briefly to view each existing setpoint, if one has already been set. The LEDs to the right of the display will illuminate to show you which alarm channel you are viewing.



The display will show (in dim numerals) the existing setpoint level for that alarm, or it will show **OFF** if that alarm has not yet been given a mode.

If the setpoint was displayed, and you want to change it, press the Alarm button for a further 3 seconds, and you will see the prompt **SetPnt**. You can now change the upper setpoint value. Use the DIGIT button to select each digit in turn, and the UP or DOWN button to change the value of each digit. When you have edited the setpoint and want to save it, press OK.

If you want to change the Alarm Configuration, press the Alarm button and wait until the display shows **AL CF9**. Other prompts such as **SetPnt** may appear first, but do not release the alarm button until you see **AL CF9**. This will take between 3 and 6 seconds to appear.

You will see the existing mode, which may say **OFF**, **Lo**, or **H**, if you are in Easy Menu mode or **OFF**, **Lo**, **H**, **FLH**, **FLLo**, **FLH/A**, **FLLo/A**, **In.bnd**, **Out.bnd**, **PC.H**, or **PC.Lo** if you are in Advanced Menu mode.

Use the UP or Down Buttons to scroll through the available choices and press OK when you see **Out.bnd**

2

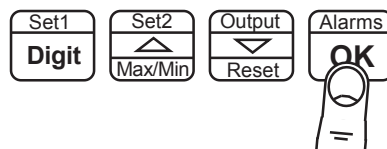

Press to accept



Now simply follow the prompts you will see, according to the list opposite, make your choices and accept with the OK button.

# Pump Control Low Alarm

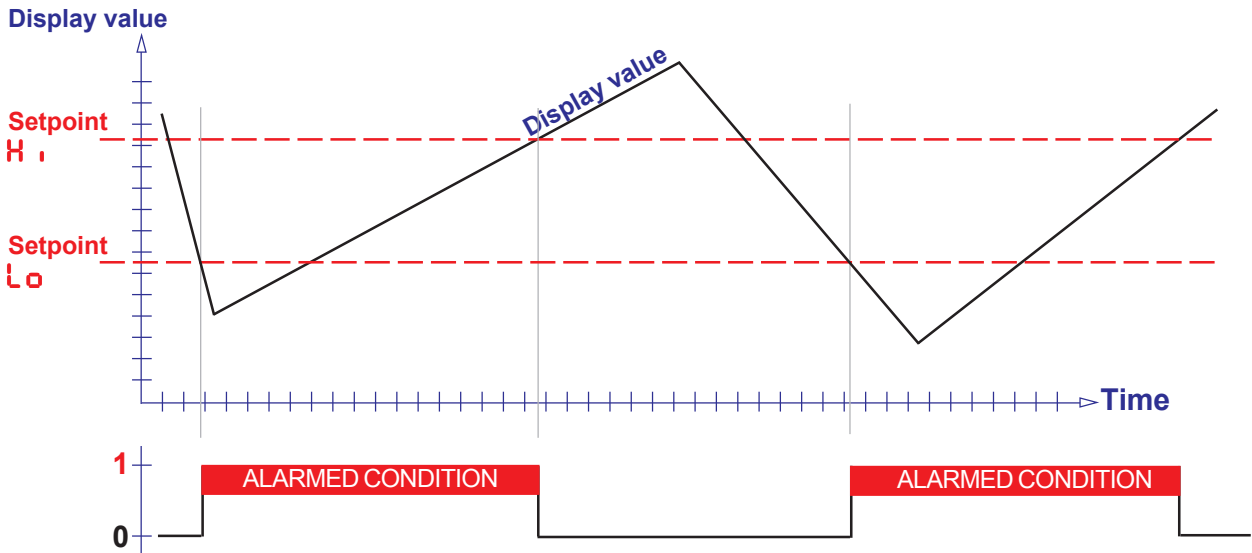

The Setpoints can be placed anywhere you like, in the range **-999999** to **+999999** and will include a decimal point in the appropriate position if you have set your display range to have a decimal point.

- Setpoint                    **SEtPt** = The upper point of the band.
- Alarm configuration    **ALCF9** , then use the UP button to choose **PCLo** = Pump Control Low alarm then press OK to accept
- Net or Gross            **Net** = alarm compared to nett value, or **Gross** = alarm compared to gross value. Use UP button to toggle between these options and press OK to accept.
- Hi Limit                    **Hi** = the upper point of the band
- Lo Limit                    **Lo** = the lower part of the band
- Relay state                **RLY dE** = Relay de-energises on trip (failsafe)  
**RLY En** = Relay energises on trip
- Relay timing              **On. tr** = Time delay in seconds from the start of an alarm condition, to the relay changing state, provided the alarm condition remains present during that period.  
  
**t. Out** = Time in seconds that the alarm relay will remain active, provided the alarm condition remains present during that period.  
  
**OFF. tr** = Time delay in seconds from an alarm condition ending, to the relay changing state. Will clear if alarm condition returns before the delay has completed.

# How to Set a Pump Control Low Alarm

1

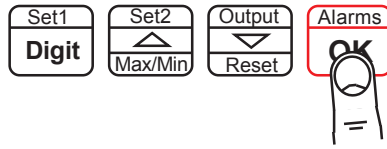

Lockout Switch must be OFF



Circuit board ON

Press briefly to view each existing setpoint, if one has already been set. The LEDs to the right of the display will illuminate to show you which alarm channel you are viewing.



The display will show (in dim numerals) the existing setpoint level for that alarm, or it will show **OFF** if that alarm has not yet been given a mode.

If the setpoint was displayed, and you want to change it, press the Alarm button for a further 3 seconds, and you will see the prompt **SEtPnt**. You can now change the upper setpoint value. Use the DIGIT button to select each digit in turn, and the UP or DOWN button to change the value of each digit. When you have edited the setpoint and want to save it, press OK.

If you want to change the Alarm Configuration, press the Alarm button and wait until the display shows **ALCF9**. Other prompts such as **SEtPnt** may appear first, but do not release the alarm button until you see **ALCF9**. This will take between 3 and 6 seconds to appear.

You will see the existing mode, which may say **OFF**, **Lo**, or **H**, if you are in Easy Menu mode or **OFF**, **Lo**, **H**, **FLH**, **FLLo**, **FLH.A**, **FLLo.A**, **In.bnd**, **Out.bnd**, **PC.H**, or **PC.Lo** if you are in Advanced Menu mode.

Use the UP or Down Buttons to scroll through the available choices and press OK when you see **PC.Lo**

2

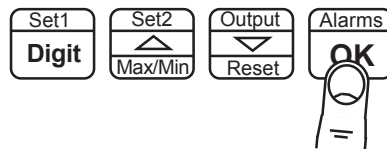

Press to accept



Now simply follow the prompts you will see, according to the list opposite, make your choices and accept with the OK button.

# Pump Control High Alarm

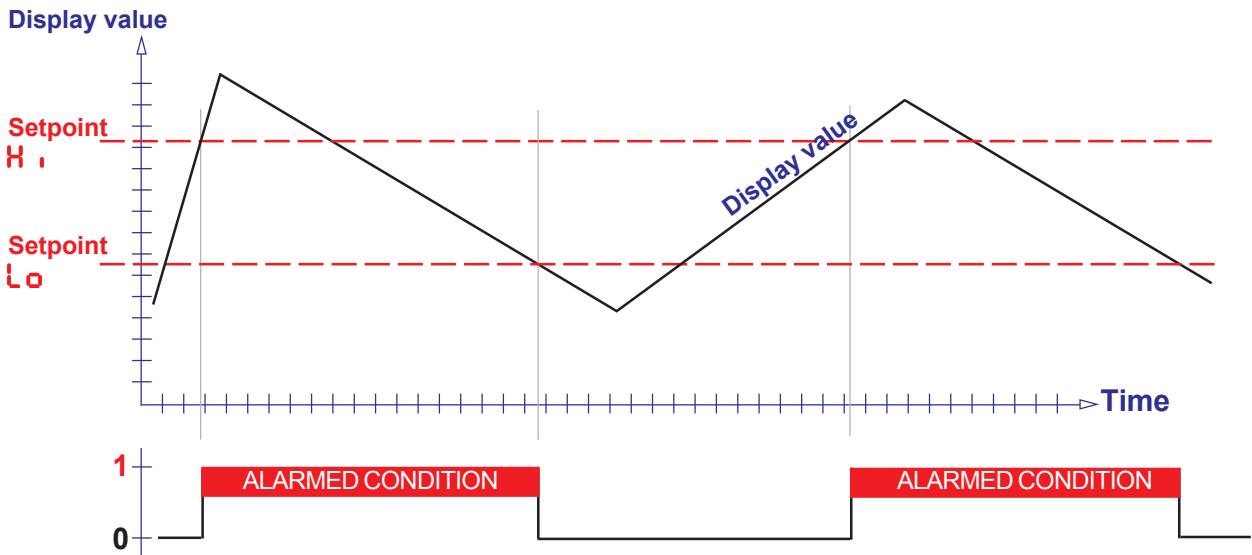

The Setpoints can be placed anywhere you like, in the range **-999999** to **+999999** and will include a decimal point in the appropriate position if you have set your display range to have a decimal point.

- Setpoint                    **SEt.Pnt** = The upper point of the band.
- Alarm configuration    **ALCF9** , then use the UP button to choose **PC.Hi** = Pump Control High alarm then press OK to accept
- Net or Gross            **Net** = alarm compared to nett value, or **Gross** = alarm compared to gross value. Use UP button to toggle between these options and press OK to accept.
- Hi Limit                    **Hi** = the upper point of the band
- Lo Limit                    **Lo** = the lower part of the band
- Relay state                **RLY dE** = Relay de-energises on trip (failsafe)  
**RLY En** = Relay energises on trip
- Relay timing              **On. tr** = Time delay in seconds from the start of an alarm condition, to the relay changing state, provided the alarm condition remains present during that period.  
**t. Out** = Time in seconds that the alarm relay will remain active, provided the alarm condition remains present during that period.  
**OFF. tr** = Time delay in seconds from an alarm condition ending, to the relay changing state. Will clear if alarm condition returns before the delay has completed.

# How to Set a Pump Control High Alarm

1

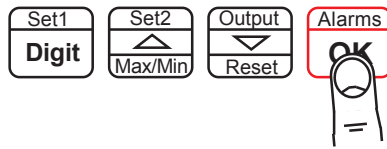

Lockout Switch must be OFF



Circuit board ON

Press briefly to view each existing setpoint, if one has already been set. The LEDs to the right of the display will illuminate to show you which alarm channel you are viewing.



The display will show (in dim numerals) the existing setpoint level for that alarm, or it will show **OFF** if that alarm has not yet been given a mode.

If the setpoint was displayed, and you want to change it, press the Alarm button for a further 3 seconds, and you will see the prompt **SEtPnt**. You can now change the upper setpoint value. Use the DIGIT button to select each digit in turn, and the UP or DOWN button to change the value of each digit. When you have edited the setpoint and want to save it, press OK.

If you want to change the Alarm Configuration, press the Alarm button and wait until the display shows **AL CF9**. Other prompts such as **SEtPnt** may appear first, but do not release the alarm button until you see **AL CF9**. This will take between 3 and 6 seconds to appear.

You will see the existing mode, which may say **OFF**, **Lo**, or **H**, if you are in Easy Menu mode or **OFF**, **Lo**, **H**, **FL.H**, **FL.Lo**, **FL.H.A**, **FL.Lo.A**, **In.bnd**, **Out.bnd**, **PC.H**, or **PC.Lo** if you are in Advanced Menu mode.

Use the UP or Down Buttons to scroll through the available choices and press OK when you see **PC.H**.

2

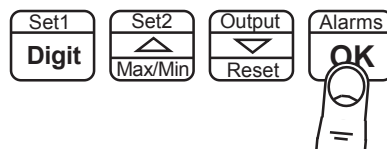

Press to accept



Now simply follow the prompts you will see, according to the list opposite, make your choices and accept with the OK button.

# Easy or Advanced Menu Mode

You can choose from two menu modes.

**1. Easy Mode** - This limits the menu to the most commonly required features, in order to make it less complex and easier to navigate. This is the default level.



**2. Advanced Mode** - This gives you access to all available menu features.



Each menu feature in this manual has a heading note to tell you whether it is available in Easy or Advanced mode.

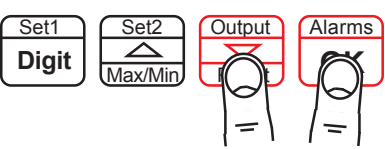

How to choose menu mode:-

**This feature is available in Easy and Advanced Modes**

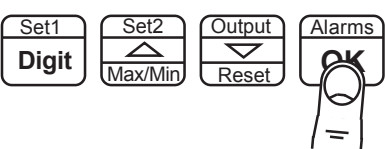
**1**  **Lockout Switch must be OFF**   
Circuit board ON  
Press together briefly

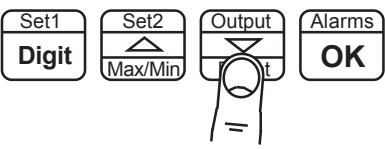
**2**  Press briefly

**3**  Each press of the DOWN arrow, or UP arrow will alternate between showing **Adv.** or **EASY**  
Press to toggle

**4**   **Done!**  
Press to accept

# Specifications

## Mechanical Relays

Formats	2 or 4 alarms SPST 2 alarms SPDT
Contact Rating	2 Amperes at 250 VAC, resistive load.  All relays must switch power from the same phase.  Selectable normally open or normally closed by on-board switches.  Selectable energise or de-energise on trip by menu.

## Solid State Relays

Contact Rating	TLP3063 100 mA max at 250 VAC  All relays must switch power from the same phase.  Selectable energise or de-energise on trip by menu.
----------------	---

## Common Features

Annunciation	4 LEDs to the right of the display. Top LED = AL1, Bottom LED = AL4 Annunciators are active even if alarm relays have not been installed. LED lights to indicate the relay is in alarm state, while power is available to the display. LED does not indicate whether the relay is energized or de-energized.
Response speed	Relays are compared to displayed value and setpoint. If the display has filtering, the alarm speed will be directly related to display update speed.  Analog input displays normally update 10 times per second, and the mechanical relays have a 5mS response speed, so please allow 105 mS for a reponse to input signal change.  Pulse input displays update 10 times per second for input pulse rates greater than 10 Hz, or update at the input pulse rate for frequencies below 10 Hz. Mechanical alarm relays will respond 5 mS after display value change.  Solid state relays do not have the 5 mS mechanical response delay.
Security	All settings are stored in non-volatile memory. The Alarm section may be left accessible to operators or may be locked from access.

# Record of Revisions

20 August 2010	R	Revision 1 version of manual released.
26 November 2010		Software F00.20 released
2 February 2011		Software F00.21 released
9 March 2017		INT4 software format released

**Software version F00.21**

Revision:4 Dated: 28 February 2011