



Medium Voltage Indoor Voltage Transformer Models PTG4-1-75 & PTG4-2-75

REGULATORY AGENCY APPROVALS



Manufactured to meet the requirements of ANSI/IEEE C57.13.

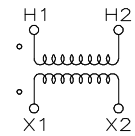
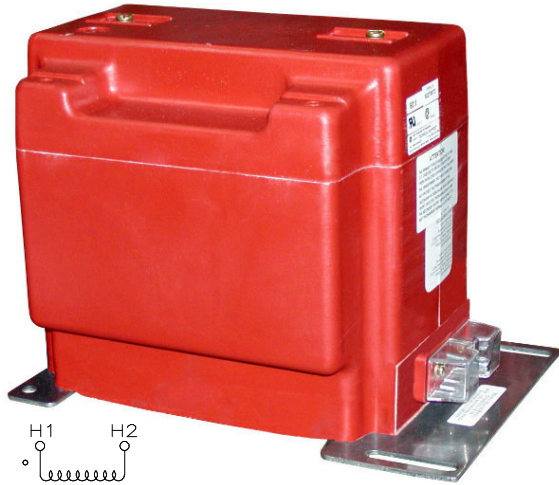

**UNFUSED
Two Bushing**

ACCURACY CLASS:

0.3 WXYM 1.2ZZ at 100% rated voltage with 120V based ANSI burden.

0.3 WXYM, 1.2Z at 58% rated voltage with 69.3V based ANSI burden.

FREQUENCY:

60 Hz.

MAXIMUM SYSTEM VOLTAGE:

9.52kV, BIL 75kV.

THERMAL RATING:

1500 VA at 30°C amb.

1000 VA at 55°C amb.

Approximate weight 85 lbs. unfused.

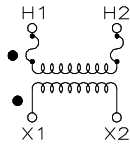
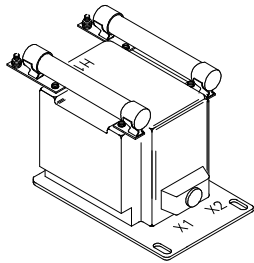

**TWO FUSE
Two Bushing**

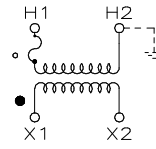
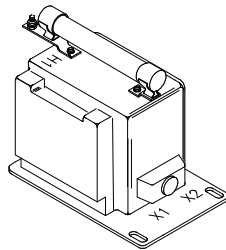

**ONE FUSE
One Bushing**

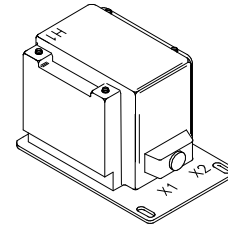

**SWITCHGEAR
STYLE
Two Bushing**

TWO BUSHING (a)				CATALOG NUMBERS			
GROUP	PRIMARY VOLTAGE	RATIO	SECONDARY VOLTAGE	UNFUSED	FUSES	FUSE CLIPS ONLY	SWITCHGEAR STYLE
1	*4200	35:1	120	PTG4-2-75-422	PTG4-2-75-422FF	PTG4-2-75-422CC	PTG4-2-75-422SS
2	*4800	40:1	120	PTG4-2-75-482	PTG4-2-75-482FF	PTG4-2-75-482CC	PTG4-2-75-482SS
2	6600	60:1	110-50 Hz	PTG4-2-75-662	PTG4-2-75-662FF	PTG4-2-75-662CC	PTG4-2-75-662SS
2	*7200	60:1	120	PTG4-2-75-722	PTG4-2-75-722FF	PTG4-2-75-722CC	PTG4-2-75-722SS
2	8400	70:1	120	PTG4-2-75-842	PTG4-2-75-842FF	PTG4-2-75-842CC	PTG4-2-75-842SS

ONE BUSHING (b)				CATALOG NUMBERS			
GROUP	PRIMARY VOLTAGE	RATIO	SECONDARY VOLTAGE	R FR (c)	FUSES	FUSE CLIPS ONLY	SWITCHGEAR STYLE
4A	*4200	35:1	120	65	PTG4-1-75-422F	PTG4-1-75-422C	PTG4-1-75-422S
4A	*4800	40:1	120	65	PTG4-1-75-482F	PTG4-1-75-482C	PTG4-1-75-482S
4B	6600	60:1	110-50 Hz	65	PTG4-1-75-662F	PTG4-1-75-662C	PTG4-1-75-662S
4B	*7200	60:1	120	65	PTG4-1-75-722F	PTG4-1-75-722C	PTG4-1-75-722S
4B	8400	70:1	120	65	PTG4-1-75-842F	PTG4-1-75-842C	PTG4-1-75-842S

NOTE: All Primary voltages marked with an asterisk (*) are approved for revenue metering in Canada by Industry Canada, Approval No. AE-0429

Models PTG4-1-75 & PTG4-2-75

(a) Two fuse transformers should not be used for Y connections. It is preferred practice to connect one lead from each voltage transformer directly to the neutral terminal, using a fuse in the line side of the primary only. By using this connection a transformer can never be made "live" from the line side by reason of a blown fuse in the neutral side.

For continuous operation the transformer primary voltage should not exceed 110% of rated value.

(b) Voltage transformers connected line-to-ground cannot be considered to be grounding transformers and must not be operated with the secondaries in closed delta because excessive currents may flow in the delta.

(c) See page 32, item 1 for ferroresonance considerations. Values in table are in ohms.

Note: It is recommended that system line-to-line voltage not exceed the transformer maximum system voltage level.

FUSE FOR MODEL PTG4 TRANSFORMER	RATING VOLTS	INTERRUPTING AMPERES (SYM)	SUGGESTED RATING CONTINUOUS AMPERES	CAP DIA. INCHES	LENGTH INCHES	CLIP CENTERS INCHES
4200:120V	15.5kV	80,000	2.0E	1.63	13	11.50
4800:120V	15.5kV	80,000	2.0E	1.63	13	11.50
6600:110V	15.5kV	80,000	1.0E	1.63	13	11.50
7200:120V	15.5kV	80,000	1.0E	1.63	13	11.50
8400:120V	15.5kV	80,000	1.0E	1.63	13	11.50

- Primary terminals that are unfused are 1/4-20 brass screws with one flatwasher and lockwasher.
- Primary terminals that are fused are 1/4-20 brass screws with one flatwasher and lockwasher and two nuts.
- Secondary terminals are No. 10-32 brass screws with one flatwasher and lockwasher.
- The core and coil assembly is vacuum encapsulated in polyurethane resin.
- Thermal burden rating is for 120 volt secondaries.
- Switch gear style is similar to fused style. No fuse or fuse clip is provide, but inserts for fuse clips are supplied.
- A test card is provided with each unit.

RECOMMENDED MINIMUM SPACINGS

A = Unit to Unit or to Ground = 1.00" minimum.

B = HV to Ground in air = 4.50" minimum.

Recommended spacing are for guidance only. User needs to set appropriate values to assure performance for high potential test, impulse test, high humidity, partial discharge, high altitude, and other considerations like configuration.

CIRCLE DIAGRAM

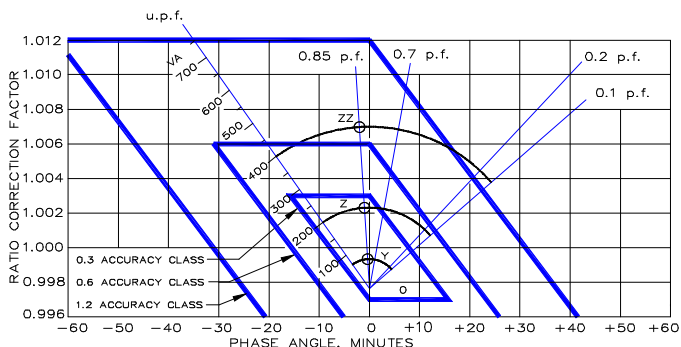

The circle diagram can be used to predict the performance of a transformer for various loads and power factors. A convenient scale of volt-ampere is shown on the unity power factor line (u.p.f) and commences at the zero or no-load locus. To use the diagram, measure the known V.A. and scribe an arc about the "Zero" locus of a length that contains the angle of the burden power factor. The point at which the arc terminates is the error locus in phase angle minutes and ratio correction factor.

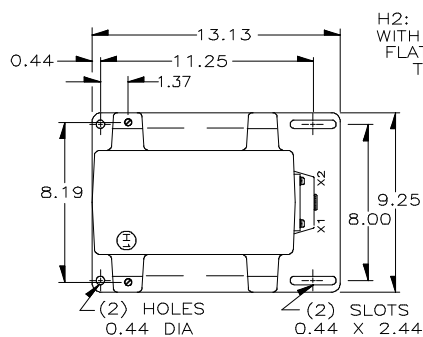
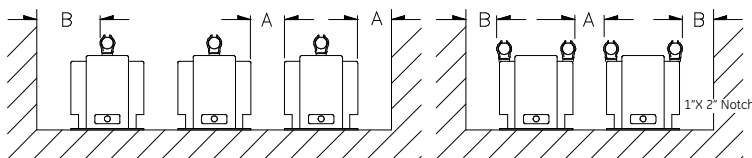

H2: 1/4-20 STUD WITH LOCKWASHER, FLATWASHER AND TWO NUTS

