

INTRODUCTION

The SC-651 split-core current sensor monitors line current for electrical loads such as pumps, conveyors, machine tools or fans and provides a 0-10 Vdc analog output to represent the load current. The SC-651 split-core series opens to allow for ease of installation on existing electrical cables.

The sensor requires no external power supply as it is totally powered by induction from the AC line being monitored. The output signal is factory calibrated with either single or multiple range products available.

The sensors are typically used to monitor AC motor operation and can be used to determine motor failure, belt loss, machine feed rates or tool wear.

WARNING

- **Electric shock hazard, use caution**
- Disconnect and lock out power before installation
- Follow national and local electrical codes
- Read and understand these instructions before installing
- Installation only by qualified electrical personnel
- Do not rely on this device to indicate line power
- Only install this device on insulated conductors
- Only install on 600 Vac maximum conductors
- Do not use this device for life-safety applications
- Do not install in hazardous or classified locations
- Install this product in a suitable electrical enclosure
- **Failure to follow these instructions will result in death or serious injury**

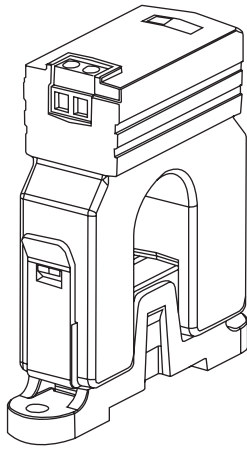

INSTALLATION

Read all warnings before beginning installation of this device. Ensure the selected device has the correct ratings for your application. Set the range switch to the desired range. See Figure 1. The SC-651-200 has one fixed range of 0-200 Amps. See Figure 2. **Disconnect and lock out power.** Mount the sensor with two screws through the base or snap onto a standard DIN mounting rail.

The base has an integrated mounting tab to allow either screw mounting to a surface or spring mounting to a DIN rail.

To mount the device to a flat surface, select an area that will allow side and top access to wire the device. If pre-drilling is required, the device may be used to mark holes. The mounting holes in the base will accommodate up to a #10 size screw (Not supplied). See Figure 3.

For DIN rail mounting, hook one side to the DIN rail and snap onto the rail. See Figure 4.

For ease of installation of either screw or DIN rail mounting, the base may be removed from the sensor, installed and the sensor inserted.

The SC-651 may be opened by slightly pulling the tab and pulling upward and swiveling the device. See Figure 5.

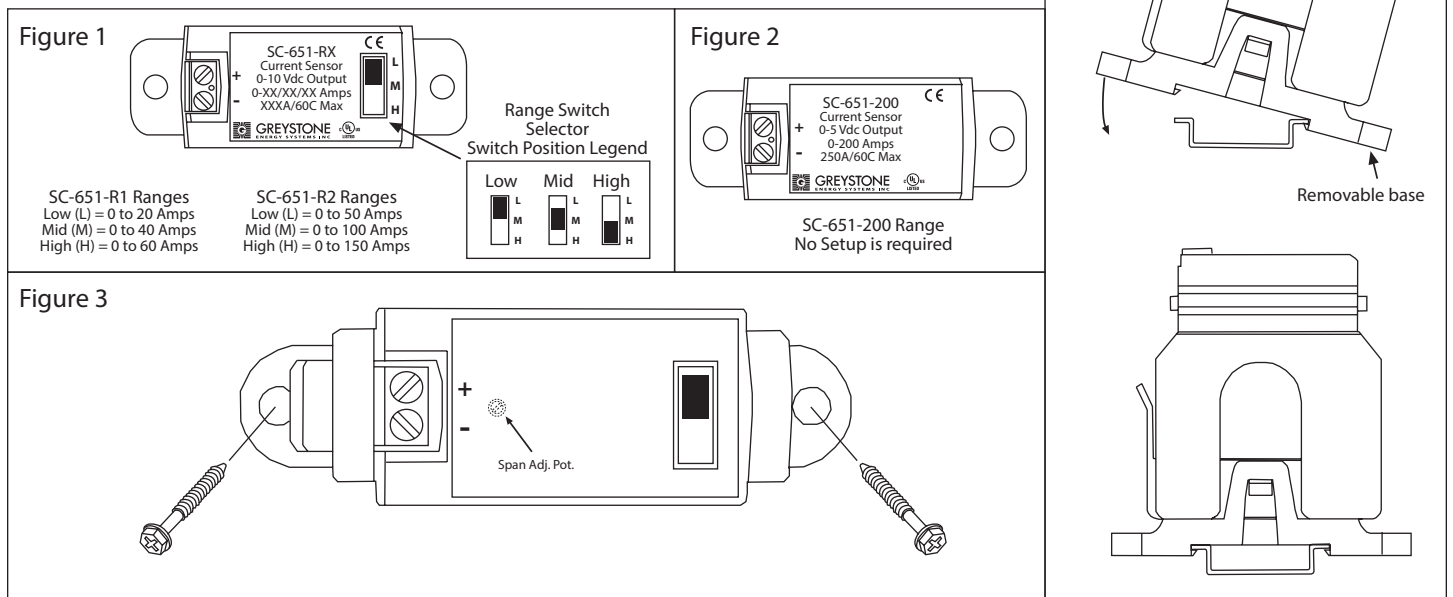

Place the monitored conductor (must be insulated) through the sensor hole and close the sensor until snapped into place. See Figure 6. Observe polarity and wire the output to the controller. Use 14-22 AWG shielded wiring for all connections and do not locate the device wires in the same conduit with wiring used to supply inductive loads such as motors. Make all connections in accordance with national and local codes. See Figure 6.-Ensure the controller scale matches the sensed range. See specifications for model ranges. Reconnect the power.

APPLICATION

All models are factory calibrated to operate within $\pm 2\%$ of FSO. If field calibration is required or a custom measurement range is desired, simply peel back the top label to expose the calibration pot. See Figure 3. The adjustment pot sets the current span of the device and may be adjusted by about $\pm 20\%$ of FSO.

For applications with load currents exceeding the sensor current ranges use an external CT to reduce the current to an acceptable value. For example, to measure a 500 Amp load current, use a 500A:5A CT and wrap the CT secondary through the SC-651-R1 four times on the 20 Amp range so the sensor output will be 0-10 Vdc = 0-500 Amps.

For applications with small load currents (such as less than 5 Amps), wrap the monitored conductor through the sensor aperture several times to increase the current measured by the sensor. For example, to measure 0-5 Amps with a SC-651-R1, wrap the conductor through the sensor aperture 4 times on the 20 Amp range so the sensor output will be 0-10 Vdc = 0-5 Amps.

For external CT or multiple wrap applications, ensure the controller is scaled accordingly to obtain correct readings.

For any application with multiple wraps, note that the SC-651 maximum current rating must be divided by the number of wraps. For example, with one wrap the maximum current is 100 Amps, with 5 wraps the maximum current is $100/5 = 20$ Amps. Ensure the load current is < 20 Amps or the device may overheat and be damaged.

Note: These may not be practical applications, select the correct device for the current range required.

SPECIFICATIONS

Measurement Range.....	SC-651-R1: 0-20/40/60 Amps SC-651-R2: 0-50/100/150 Amps SC-651-200: 0-200 Amps
Maximum Input Current.....	SC-651-R1: 100 Amps Continuous SC-651-R2: 150 Amps Continuous SC-651-200: 225 Amps Continuous
Accuracy	SC-651-R1/R2: $\pm 2\%$ FSO (5 to 100% of range) SC-651-200: $\pm 1\%$ FSO (5 to 100% of range)
Signal Output.....	0-10 Vdc
Sensor Power	Self-powered
Insulation Class	600 Vac, insulated conductors
Frequency	50/60 Hz
Response Time	200 mS typical, 0 to 90%
Output Load	1 M Ω typical
Loading Error	Add 0.5% error with 100K Ω
Operating Temperature.....	-15 to 60°C (5 to 140°F)
Operating Humidity	5 to 90 %RH non-condensing
Terminal Block	14 to 22 AWG
Dimensions.....	76mm W x 79mm H x 24.9mm D (3" x 3.1" x 0.98")
Sensor Aperture.....	20.3mm (0.8")
Enclosure Material.....	ABS/PC, UL94 V-0
Agency Approvals	cULus Listed
Country of Origin.....	Canada

DIMENSIONS

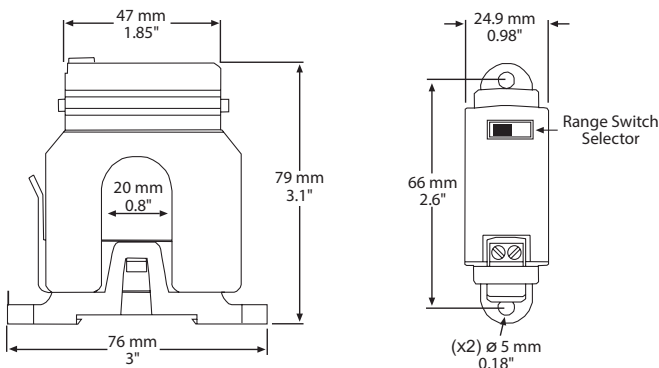

Figure 5

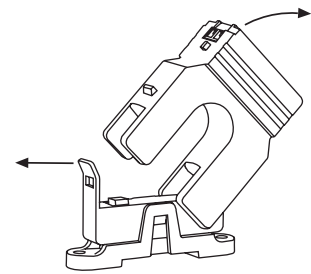
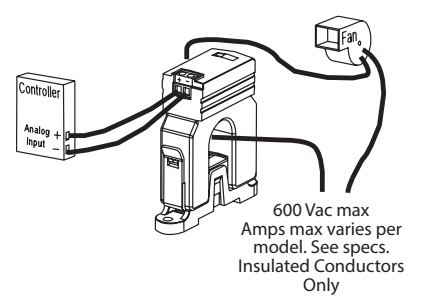
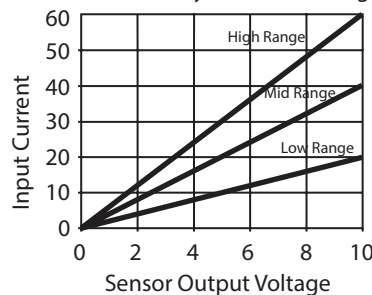

Figure 6



SC-651-R1 Factory Calibrated Ranges



SC-651-R2 Factory Calibrated Ranges

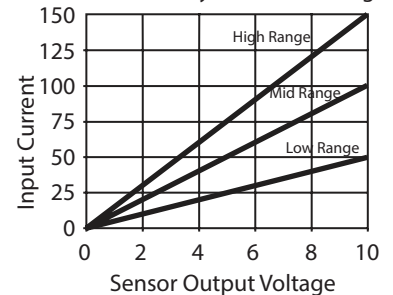

SC-651-200 Factory Calibrated Range

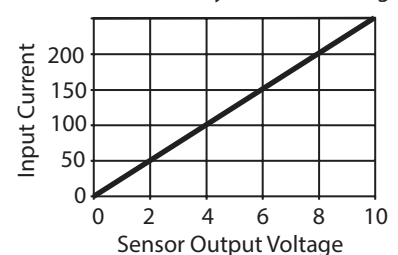

PRINTED IN CANADA